

MAGNEHELIC® DIFFERENTIAL PRESSURE GAGES

Indicate Positive, Negative or Differential, Accurate within 1%



Standard Magnehelic® Gage



High Accuracy Magnehelic® Gage
Note: Shown with optional -SS bezel

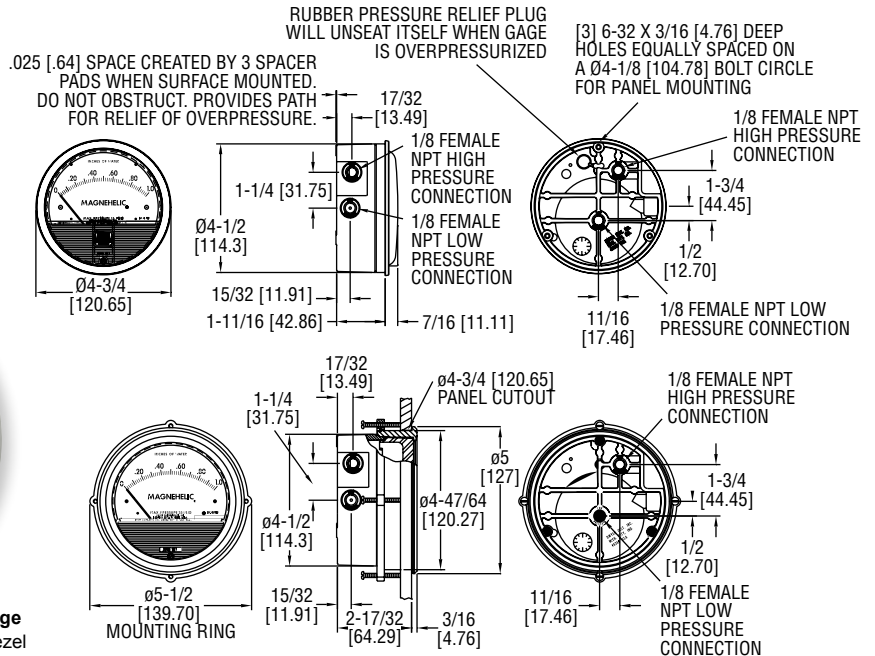

Select the **SERIES 2000** Magnehelic® Gage for a versatile low differential pressure gage with a wide choice of 81 models and 27 options to choose from. Using Dwyer's simple, frictionless Magnehelic® gage movement, it quickly indicates air or non-corrosive gas pressures--either positive, negative (vacuum) or differential. The design resists shock, vibration, over-pressures and is weatherproof to IP67. Select the -HA High Accuracy Magnehelic Gage® option for an accuracy within 1% of full scale. Also included with the -HA option at no extra cost are a mirrored scale overlay and a 6 point calibration certificate.

FEATURES/BENEFITS

- Easy to read gage through undistorted plastic face permits viewing from far away
- Patented design provides quick response to pressure changes means no delay in assessing critical situations
- Durable and rugged housing and high-quality components combine to provide long-service life and minimized down-time
- High accuracy option is twice as accurate as the standard Magnehelic® gage.

APPLICATIONS

- Filter monitoring
- Air velocity with Dwyer pitot tube
- Blower vacuum monitoring
- Fan pressure indication
- Duct, room or building pressures
- Clean room positive pressure indication

ACCESSORIES

Model	Description
A-432	Portable kit; combine carrying case with any Magnehelic® gage of standard range, except high pressure connection. Includes 9 ft (2.7 m) of 3/16" ID rubber tubing, standhang bracket and terminal tube with holder
A-605	Air filter gage accessory kit; adapts any standard Magnehelic® gage for use as an air filter gage. Includes aluminum surface mounting bracket with screws, two 5 ft (1.5 m) lengths of 1/4" aluminum tubing, two static pressure tips and two molded plastic vent valves, integral compression fittings on both tips and valves
A-605B	Air filter gage accessory kit; air filter kit with two plastic open/close valves, two 4" steel static tips, plastic tubing and mounting flange
A-605C	Air filter gage accessory kit; air filter kit with two plastic open/close valves, two plastic static tips, plastic tubing and mounting flange

SPECIFICATIONS

Service: Air and non-combustible, compatible gases (natural gas option available). **Note:** May be used with hydrogen. Order a Buna-N diaphragm. Pressures must be less than 35 psi.
Wetted Materials: Consult factory.
Housing: Die cast aluminum case and bezel, with acrylic cover. Exterior finish is coated gray to withstand 168 hour salt spray corrosion test.
Accuracy: ±2% (-HA model ±1) of FS (±3% (-HA ±1.5%) on -0, -100PA, -125PA, -10MM and ±4% (-HA ±2%) on -00, -60PA, -6MM ranges), throughout range at 70°F (21.1°C).
Pressure Limits: -20 in Hg to 15 psig† (-0.677 to 1.034 bar); MP option: 35 psig (2.41 bar); HP option: 80 psig (5.52 bar).
Enclosure Rating: IP67.
Overpressure: Relief plug opens at approximately 25 psig (1.72 bar), standard gages only. ⚠

Temperature Limits: 20 to 140°F* (-6.67 to 60°C). -20°F (-28°C) with low temperature option.
Size: 4" (101.6 mm) diameter dial face.
Mounting Orientation: Diaphragm in vertical position. Consult factory for other position orientations.
Process Connections: 1/8" female NPT duplicate high and low pressure taps - one pair side and one pair back.
Weight: 1 lb 2 oz (510 g), MP & HP 2 lb 2 oz (963 g).
Standard Accessories: Two 1/8" NPT plugs for duplicate pressure taps, two 1/8" pipe thread to rubber tubing adapter, and three flush mounting adapters with screws. (Mounting and snap ring retainer substituted for three adapters in MP & HP gage accessories.)
Agency Approvals: Meets the technical requirements of EU Directive 2011/65/EU (RoHS II). **Note:** -SP models not RoHS approved.

Note: For applications with high cycle rate within gage total pressure rating, next higher rating is recommended. See Medium and High pressure options.

*Low temperature models available as special options.



A-432



A-605

MAGNEHELIC® DIFFERENTIAL PRESSURE GAGES

Indicate Positive, Negative or Differential, Accurate within 2%

Bezel provides flange for flush mounting in panel.

Clear plastic face is highly resistant to breakage. Provides undistorted viewing of pointer and scale.

Precision litho-printed scale is accurate and easy to read.

Calibrated range spring is flat spring steel. Small amplitude of motion assures consistency and long life. It reacts to pressure on diaphragm. Live length adjustable for calibration.

Red tipped pointer of heat treated aluminum tubing is easy to see. It is rigidly mounted on the helix shaft.

Pointer stops of molded rubber prevent pointer over-travel without damage.

“Wishbone” assembly provides mounting for helix, helix bearings and pointer shaft.

Jeweled bearings are shock-resistant mounted; provide virtually friction-free motion for helix. Motion damped with high viscosity silicone fluid.

Helix is precision made from an alloy of high magnetic permeability. Mounted in jeweled bearings, it turns freely, following the magnetic field to move the pointer across the scale.

Zero adjustment screw is conveniently located in the plastic cover, and is accessible without removing cover. O-ring seal provides pressure tightness.

O-ring seal for cover assures pressure integrity of case.

OVERPRESSURE PROTECTION
Blowout plug is comprised of a rubber plug on the rear which functions as a relief valve by unseating and venting the gage interior when over pressure reaches approximately 25 psig (1.7 bar). To provide a free path for pressure relief, there are four spacer pads which maintain 0.023” clearance when gage is surface mounted. Do not obstruct the gap created by these pads.

The blowout plug is not used on models above 180” of water pressure, medium or high pressure models, or on gages which require an elastomer other than silicone for the diaphragm.

The blowout plug should not be used as a system overpressure control. High supply pressures may still cause the gage to fail due to over pressurization, resulting in property damage or serious injury. Good engineering practices should be utilized to prevent your system from exceeding the ratings of any component.

Die cast aluminum case is precision made and iridite-dipped to withstand 168 hour salt spray corrosion test. Exterior finished in baked dark gray hammerloid. One case size is used for all standard pressure options, and for both surface and flush mounting.

Silicone rubber diaphragm with integrally molded O-ring is supported by front and rear plates. It is locked and sealed in position with a sealing plate and retaining ring. Diaphragm motion is restricted to prevent damage due to overpressures.

Samarium Cobalt magnet mounted at one end of range spring rotates helix without mechanical linkages.

ULTERIORI SCALE NELLE ULTIME PAGINE

MODEL CHART							
Model	Range, Inches of Water	Model	Range, PSI	Model	Range, MM of Water	Model	Range, kPa
2000-00N†	0-0.2	2201	0-1	2000-6MM†	0-6	2000-0.5KPA	0-0.5
2000-00†	0-0.25	2202	0-2	2000-10MM†	0-10	2000-1KPA	0-1
2000-0†	0-0.50	2203	0-3	2000-15MM	0-15	2000-1.5KPA	0-1.5
2001	0-1.0	2204	0-4	2000-25MM	0-25	2000-2KPA	0-2
2002	0-2.0	2205	0-5	2000-30MM	0-30	2000-2.5KPA	0-2.5
2003	0-3.0	2210*	0-10	2000-50MM	0-50	2000-3KPA	0-3
2004	0-4.0	2215*	0-15	2000-80MM	0-80	2000-4KPA	0-4
2005	0-5.0	2220*	0-20	2000-100MM	0-100	2000-5KPA	0-5
2006	0-6.0	2230**	0-30	2000-125MM	0-125	2000-8KPA	0-8
2008	0-8.0			2000-150MM	0-150	2000-10KPA	0-10
2010	0-10			2000-200MM	0-200	2000-15KPA	0-15
2012	0-12			2000-250MM	0-250	2000-20KPA	0-20
2015	0-15			2000-300MM	0-300	2000-25KPA	0-25
2020	0-20					2000-30KPA	0-30
2025	0-25						
2030	0-30						
2040	0-40						
2050	0-50						
2060	0-60						
2080	0-80						
2100	0-100						
2120	0-120						
2150	0-150						
2160	0-160						
2180*	0-180						
2250*	0-250						
		Model	Range, CM of Water	Zero Center Ranges			
		2000-15CM	0-15	2300-6MM†	3-0-3	2300-1KPA	5-0-.5
		2000-20CM	0-20	2300-10MM†	5-0-5	2300-2KPA	1-0-1
		2000-25CM	0-25	2300-20MM†	10-0-10	2300-2.5KPA	1.25-0-1.25
		2000-50CM	0-50	Zero Center Ranges			
		2000-80CM	0-80	2000-60NPA†	10-0-50	2300-3KPA	1.5-0-1.5
		2000-100CM	0-100				
		2000-150CM	0-150				
		2000-200CM	0-200				
		2000-250CM	0-250				
		2000-300CM	0-300				
		Zero Center Ranges				Dual Scale English/Metric Models	
		2300-4CM	2-0-2			Model	Range, in w.c.
		2300-10CM	5-0-5				Range, Pa or kPa
		2300-30CM	15-0-15			2000-00D†	0-25
						2000-0D†	0-0.5
						2001D	0-1.0
						2002D	0-2.0
						2003D	0-3.0
						2004D	0-4.0
						2005D	0-5.0
						2006D	0-6.0
						2008D	0-8.0
						2010D	0-10
						2015D	0-15
						2020D	0-20
						2025D	0-25
						2050D	0-50
						2060D	0-60

†These ranges calibrated for vertical scale position • Accuracy ±3% ** Accuracy ±4% *MP option standard **HP option standard

VELOCITY AND VOLUMETRIC FLOW UNITS

Scales are available on the Magnehelic® that read in velocity units (FPM, m/s) or volumetric flow units (SCFM, m³/s, m³/h). Stocked velocity units with dual range scales in inches w.c. and feet per minute are shown above. For other ranges contact the factory. When ordering volumetric flow scales please specify the maximum flow rate and its corresponding pressure.

ACCESSORIES

Model	Description
A-321	Safety relief valve
A-448	3-piece magnet kit for mounting Magnehelic® gage directly to magnetic surface
A-135	Rubber gasket for panel mounting
A-401	Plastic carry case
A-310A	3-way vent valves. In applications where pressure is continuous and the Magnehelic® gage is connected by metal or plastic tubing which cannot be easily removed, we suggest using Dwyer A-310A vent valves to connect gage. Pressure

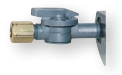



HIGH ACCURACY MAGNEHELIC® DIFFERENTIAL PRESSURE GAGE

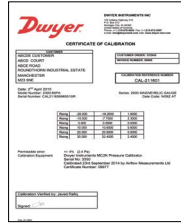
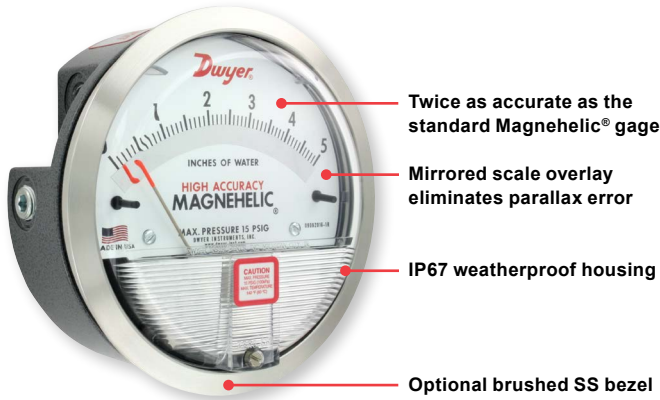

6-Point Calibration Certificate Included

OPTIONS - HIGH ACCURACY MAGNEHELIC® GAGE	
To order add suffix:	Description
-HA	High Accuracy Magnehelic® Gage. Accuracy within 1% and weatherproof. Also includes mirrored scale overlay and a six point calibration certificate
-SS	Corrosion resistant brushed 304 stainless steel bezel

Accuracy Specifications: See page 20 (Series 2000)

ADDITIONAL GAGE OPTIONS



OPTIONS - OTHER OPTIONAL BEZELS	
To order add suffix:	Description
-CB	Chrome bezel option: A chrome plated aluminum bezel for an aesthetically pleasing finish when mounting on metal surfaces such as control panels.
-SB	Stainless steel bezel option: 304 stainless steel electro polished Ra 16 finished bezel.
-SS	Corrosion resistant brushed 304 stainless steel bezel



LED Setpoint Indicator

Adjustable Signal Flag

OPTION - LED SETPOINT INDICATOR	
To order add suffix:	Description
-SP	Bright red LED on right scale shows when setpoint is reached. Field adjustable from gage face, unit operates on 12-24 VDC. Setpoint indicator option comes with medium pressure (MP) bezel.

Note: 4-13/16" hole for flush mounting.



Transparent Overlay

Mirrored Scale Overlay

OPTION - ADJUSTABLE SIGNAL FLAG	
To order add suffix:	Description
-ASF	Integral with plastic gage cover. Available for most models except those with medium or high pressure construction. Can be ordered with gage or separate.

OPTIONS - TRANSPARENT OVERLAYS	
To order add suffix:	Description
-G	Green (to highlight and emphasize critical pressures) Red (to highlight and emphasize critical pressures)
-R	Yellow (to highlight and emphasize critical pressures)



Integrated Mounting Plate

OPTION - MIRRORED SCALE OVERLAY	
To order add suffix:	Description
-M	A mirrored scale overlay is also available to assist in reducing parallax error.

OPTIONS - INTEGRATED MOUNTING PLATE	
To order add suffix:	Description
-AHU1	Furnished with attached surface mounting plate
-AHU2	Furnished with attached surface mounting plate and including A-481 installer kit (2 plastic static pressure tips and 7' of PVC tubing)



OPTIONS - FOR HIGH STATE PRESSURE APPLICATIONS	
To order add suffix:	Description
-HP	High pressure option: for pressures to 80 psig
-MP	Medium pressure option: for pressures to 35 psig

OPTIONS	
To order add suffix:	Description
-FC	Factory calibration certificate
-LT	Low temperatures to -20°F (-28°C)



Magnehelic® Gage Mounting Accessories

MOUNTING. A single case size is used for most models of Magnehelic® gages. They can be flush or surface mounted with standard hardware supplied. Complete mounting and connection fittings plus instructions are furnished with each instrument. A 4-9/16" hole is required for flush panel mounting.

Flush mounting is easily accomplished with the new A-300 Flush Mounting bracket. This bracket provides a solution to quickly and conveniently flush mount the Magnehelic®. The A-300 is ideal for mounting the Magnehelic® on control panel doors.

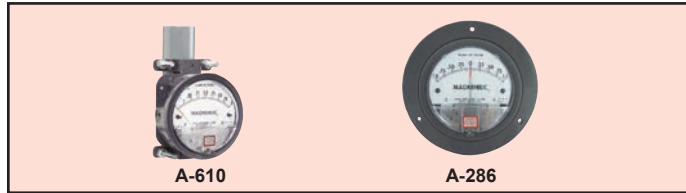

A-610

A-286



A-369

A-369

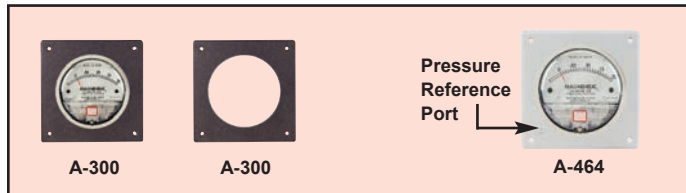

A-300

A-300

Pressure Reference Port

A-464

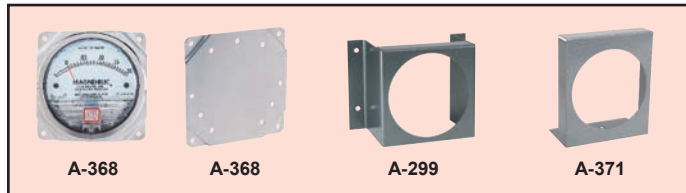

A-368

A-368

A-299

A-371

The A-368 is a simple bracket for quickly surface mounting the Magnehelic® gage. After securing the Magnehelic® to the A-368 bracket, mount the bracket on any flat surface.

The A-369 allows the Magnehelic® to be easily carried to locations where pressure readings need to be taken. The A-369 can stand on its own or hang on a nail or hook.

PIPE

A-610, Pipe Mounting Kit for installing on 1-1/4" to 2" horizontal or vertical pipe

PANEL

A-286, Magnehelic® Gage Panel Mounting Flange

PORTABLE

A-369, Stand-Hang Bracket, aluminum, for Magnehelic® gage

FLUSH

A-300, Flush Mounting Bracket

A-464, Flush Mount Kit for Magnehelic® Gages

SURFACE

A-368, Surface Mounting Plate, aluminum, for Magnehelic® gage

A-299, Mounting Bracket, flush mount for Magnehelic® Gage. Bracket is then surface mounted. Steel with gray hammerloid epoxy finish

A-371, Surface Mounting Bracket. Use with medium pressure (-MP) or high pressure (-HP) models only



Series A-320

Instrument Enclosure Protects Various Instruments

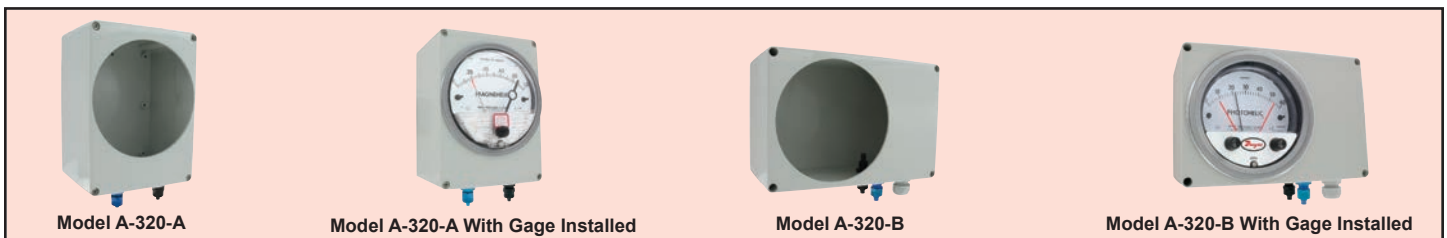

Series A-320 Instrument Enclosure protects instruments in all applications. The A-320-A fits standard Magnehelic® size instruments (4-9/16" diameter) and the A-320-B fits standard 3000MR Photohelic® switch/gage size instruments (4-13/16" diameter). Both models include silicone tubing, gage barbs and mounting hardware.

SPECIFICATIONS

Housing: ABS.

Process Connections: Anodized aluminum.

Enclosure Rating: NEMA 1 (IP10).

Note: Check instruments rating.

Weight: Model A-320-A: 11.29 oz (320 g); A-320-B: 16.23 oz (420 g).

Gage Size Opening: A-320-A: 4-9/16 in (115.89 mm); A-320-B: 4-13/16 in (122.24 mm).

Model	Compatible Instruments
A-320-A	Series 2000 Magnehelic® Gages, DM-1000 Digital Differential Pressure Gages, DM-2000 Differential Pressure Transmitter 3000MR Photohelic® Switch/Gage, Series 605 Magnehelic®
A-320-B	Differential Pressure Transmitter, DH3 Digihelic® Pressure Controller, Series 2000 Magnehelic® Gage with medium and high pressure options

ULTERIORI SCALE NELLE PAGINE SEGUENTI

Ulteriori Scale

2000-00N 0.05-0-.20" w.c.

2000-00 0-.25" w.c.

2000-0 0-.5" w.c.

2001 0-1" w.c.

2002 0-2" w.c.

2003 0-3" w.c.

2004 0-4" w.c.

2005 0-5" w.c.

2006 0-6" w.c.

2008 0-8" w.c.

2010 0-10" w.c.

2012 0-12" w.c.

2015 0-15" w.c.

2020 0-20" w.c.

2025 0-25" w.c.

2030 0-30" w.c.

2040 0-40" w.c.

2045 0-45" w.c.

2050 0-50" w.c.

2060 0-60" w.c.

2080 0-80" w.c.

2100 0-100" w.c.

2120 0-120" w.c.

2150 0-150" w.c.

2160 0-160" w.c.

2180 0-180" w.c.

2200 0-200" w.c.

2250 0-250" w.c.

2300 0-300" w.c.

2400 0-400" w.c.

2500 0-500" w.c.

2300-00 0.125-0-0.125" w.c.

2300-0 0.25-0-0.25" w.c.

2301 0.5-0-0.5" w.c.

2302 1-0-1" w.c.

2304 2-0-2" w.c.

2305 2.5-0-2.5" w.c.

2306 3-0-3" w.c.

2308 4-0-4" w.c.

2310 5-0-5" w.c.

2312 6-0-6" w.c.

2316 8-0-8" w.c.

2320 10-0-10" w.c.

2330 15-0-15" w.c.



2340 20-0-20" w.c.

2350 25-0-25" w.c.

2360 30-0-30" w.c.

2380 40-0-40" w.c.

23100 50-0-50" w.c.

23150 75-0-75" w.c.

2000-1FTWC 0-1 ft w.c.

2000-1.5FTWC 0-1.5 ft w.c.

2000-2FTWC 0-2 ft w.c.

2000-2.5FTWC 0-2.5 ft w.c.

2000-3FTWC 0-3 ft w.c.

2000-4FTWC 0-4 ft w.c.

2000-5FTWC 0-5 ft w.c.

2000-6FTWC 0-6 ft w.c.

2000-8FTWC 0-8 ft w.c.

2000-10FTWC 0-10 ft w.c.

2000-12FTWC 0-12 ft w.c.

2000-12.5FTWC 0-12.5 ft w.c.

2000-15FTWC 0-15 ft w.c.

2000-20FTWC 0-20 ft w.c.

2000-25FTWC 0-25 ft w.c.

2000-30FTWC 0-30 ft w.c.

2000-35FTWC 0-35 ft w.c.

2000-40FTWC 0-40 ft w.c.

2000-50FTWC 0-50 ft w.c.

2000-60FTWC 0-60 ft w.c.

2000-00D 0-0.25" w.c. & 0-62 Pa

2000-0D 0-0.5" w.c. & 0-125 Pa

2001D 0-1" w.c. & 0-250 Pa

2002D 0-2" w.c. & 0-500 Pa

2003D 0-3" w.c. & 0-750 Pa

2004D 0-4" w.c. & 0-1 kPa

2005D 0-5" w.c. & 0-1.25 kPa

2006D 0-6" w.c. & 0-1.5 kPa

2008D 0-8" w.c. & 0-2 kPa

2010D 0-10" w.c. & 0-2.5 kPa

2015D 0-15" w.c. & 0-3.7 kPa

2020D 0-20" w.c. & 0-5 kPa

2025D 0-25" w.c. & 0-5.2 kPa

2030D 0-30" w.c. & 0-7.5 kPa

2040D 0-40" w.c. & 0-10 kPa

2050D 0-50" w.c. & 0-12.4 kPa

2060D 0-60" w.c. & 0-15 kPa

2100D 0-100" w.c. & 0-25 kPa

2200D 0-200" w.c. & 0-50 kPa

2310D 5-0-5" w.c. & 1.25-0-1.25 kPa

2000-00AV 0-0.25" w.c. & 0-2000 FPM

2000-0AV 0-0.5" w.c. & 0-2800 FPM

2001AV 0-1" w.c. & 0-4000 FPM

2002AV 0-2" w.c. & 0-5600 FPM

2005AV 0-5" w.c. & 0-8800 FPM
 2010AV 0-10" w.c. & 0-12500 FPM
 2015AV 0-15" w.c. & 0-15500 FPM
 2020AV 0-20" w.c. & 0-17500 FPM
 2025AV 0-25" w.c. & 0-20000 FPM
 2000-00MV 0-60 Pa & 0-9.8 m/s
 2000-0MV 0-125 Pa & 0-14.4 m/s
 2001MV 0-250 Pa & 0-20 m/s
 2002MV 0-500 Pa & 0-28 m/s
 2005MV 0-1.25 kPa & 0-45 m/s
 2008MV 0-2 kPa & 0-57 m/s
 2015MV 0-3.5 kPa & 0-76 m/s
 2020MV 0-5 kPa & 0-90 m/s
 2024MV 0-6 kPa & 0-98 m/s
 2201 0-1 psid
 2202 0-2 psid
 2203 0-3 psid
 2204 0-4 psid
 2205 0-5 psid
 2206 0-6 psid
 2208 0-8 psid
 2210 0-10 psid
 2215 0-15 psid
 2220 0-20 psid
 2230 0-30 psid
 2000-0.25HG 0-.25" Hg
 2000-0.5HG 0-.5" Hg
 2000-1HG 0-1" Hg
 2000-1.5HG 0-1.5" Hg
 2000-2HG 0-2" Hg
 2000-3HG 0-3" Hg
 2000-4HG 0-4" Hg
 2000-5HG 0-5" Hg
 2000-6HG 0-6" Hg
 2000-7HG 0-7" Hg
 2000-8HG 0-8" Hg
 2000-9HG 0-9" Hg
 2000-10HG 0-10" Hg
 2000-11HG 0-11" Hg
 2000-12HG 0-12" Hg
 2000-15HG 0-15" Hg
 2000-16HG 0-16" Hg
 2000-20HG 0-20" Hg
 2000-25HG 0-25" Hg
 2000-30HG 0-30" Hg
 2000-40HG 0-40" Hg
 2000-50HG 0-50" Hg
 2000-60HG 0-60" Hg
 2300-0.5HG 0.25-0-0.25" Hg
 2300-1HG 0.5-0-0.5" Hg



2300-2HG 1-0-1" Hg
 2300-30HG 15-0-15" Hg
 2000-0.5MMHG 0-0.5 mm Hg
 2000-1MMHG 0-1 mm Hg
 2000-2MMHG 0-2 mm Hg
 2000-4MMHG 0-4 mm Hg
 2000-5MMHG 0-5 mm Hg
 2000-6MMHG 0-6 mm Hg
 2000-7MMHG 0-7 mm Hg
 2000-8MMHG 0-8 mm Hg
 2000-9MMHG 0-9 mm Hg
 2000-10MMHG 0-10 mm Hg
 2000-11MMHG 0-11 mm Hg
 2000-12MMHG 0-12 mm Hg
 2000-15MMHG 0-15 mm Hg
 2000-20MMHG 0-20 mm Hg
 2000-25MMHG 0-25 mm Hg
 2000-30MMHG 0-30 mm Hg
 2000-35MMHG 0-35 mm Hg
 2000-40MMHG 0-40 mm Hg
 2000-50MMHG 0-50 mm Hg
 2000-60MMHG 0-60 mm Hg
 2000-80MMHG 0-80 mm Hg
 2000-100MMHG 0-100 mm Hg
 2000-150MMHG 0-150 mm Hg
 2000-200MMHG 0-200 mm Hg
 2000-250MMHG 0-250 mm Hg
 2000-300MMHG 0-300 mm Hg
 2000-350MMHG 0-350 mm Hg
 2000-400MMHG 0-400 mm Hg
 2300-60MMHG 30-0-30 mm Hg
 2000-6MM 0-6 mm w.c.
 2000-8MM 0-8 mm w.c.
 2000-10MM 0-10 mm w.c.
 2000-12MM 0-12 mm w.c.
 2000-15MM 0-15 mm w.c.
 2000-20MM 0-20 mm w.c.
 2000-25MM 0-25 mm w.c.
 2000-30MM 0-30 mm w.c.
 2000-35MM 0-35 mm w.c.
 2000-40MM 0-40 mm w.c.
 2000-50MM 0-50 mm w.c.
 2000-60MM 0-60 mm w.c.
 2000-75MM 0-75 mm w.c.
 2000-80MM 0-80 mm w.c.
 2000-100MM 0-100 mm w.c.
 2000-125MM 0-125 mm w.c.
 2000-150MM 0-150 mm w.c.
 2000-200MM 0-200 mm w.c.
 2000-250MM 0-250 mm w.c.

2000-300MM 0-300 mm w.c.
 2000-350MM 0-350 mm w.c.
 2000-375MM 0-375 mm w.c.
 2000-400MM 0-400 mm w.c.
 2000-500MM 0-500 mm w.c.
 2000-600MM 0-600 mm w.c.
 2000-700MM 0-700 mm w.c.
 2000-750MM 0-750 mm w.c.
 2000-800MM 0-800 mm w.c.
 2000-1000MM 0-100 x 10 mm w.c.
 2000-1200MM 0-120 x 10 mm w.c.
 2000-1500MM 0-150 x 10 mm w.c.
 2000-1600MM 0-160 x 10 mm w.c.
 2000-1800MM 0-180 x 10 mm w.c.
 2000-2000MM 0-200 x 10 mm w.c.
 2000-3000MM 0-300 x 10 mm w.c.
 2000-4000MM 0-400 x 10 mm w.c.
 2000-5000MM 0-500 x 10 mm w.c.
 2300-6MM 3-0-3 mm w.c.
 2300-10MM 5-0-5 mm w.c.
 2300-12MM 6-0-6 mm w.c.
 2300-14MM 7-0-7 mm w.c.
 2300-20MM 10-0-10 mm w.c.
 2300-30MM 15-0-15 mm w.c.
 2300-40MM 20-0-20 mm w.c.
 2300-50MM 25-0-25 mm w.c.
 2300-60MM 30-0-30 mm w.c.
 2300-80MM 40-0-40 mm w.c.
 2300-100MM 50-0-50 mm w.c.
 2300-150MM 75-0-75 mm w.c.
 2300-160MM 80-0-80 mm w.c.
 2300-200MM 100-0-100 mm w.c.
 2300-250MM 125-0-125 mm w.c.
 2300-300MM 150-0-150 mm w.c.
 2300-320MM 160-0-160 mm w.c.
 2300-400MM 200-0-200 mm w.c.
 2300-450MM 225-0-225 mm w.c.
 2300-500MM 250-0-250 mm w.c.
 2300-600MM 300-0-300 mm w.c.
 2300-700MM 350-0-350 mm w.c.
 2300-750MM 375-0-375 mm w.c.
 2300-800MM 400-0-400 mm w.c.
 2300-1000MM 500-0-500 mm w.c.
 2000-1.5CM 0-1.5 cm w.c.
 2000-2CM 0-2 cm w.c.
 2000-2.5CM 0-2.5 cm w.c.
 2000-3CM 0-3 cm w.c.
 2000-4CM 0-4 cm w.c.
 2000-5CM 0-5 cm w.c.
 2000-6CM 0-6 cm w.c.

2000-8CM 0-8 cm w.c.
 2000-10CM 0-10 cm w.c.
 2000-15CM 0-15 cm w.c.
 2000-20CM 0-20 cm w.c.
 2000-25CM 0-25 cm w.c.
 2000-30CM 0-30 cm w.c.
 2000-35CM 0-35 cm w.c.
 2000-40CM 0-40 cm w.c.
 2000-50CM 0-50 cm w.c.
 2000-60CM 0-60 cm w.c.
 2000-80CM 0-80 cm w.c.
 2000-100CM 0-100 cm w.c.
 2000-125CM 0-125 cm w.c.
 2000-150CM 0-150 cm w.c.
 2000-200CM 0-200 cm w.c.
 2000-250CM 0-250 cm w.c.
 2000-300CM 0-300 cm w.c.
 2000-350CM 0-350 cm w.c.
 2000-400CM 0-400 cm w.c.
 2000-500CM 0-500 cm w.c.
 2000-600CM 0-600 cm w.c.
 2000-700CM 0-700 cm w.c.
 2000-1000CM 0-100 x 10 cm w.c.
 2300-2CM 1-0-1 cm w.c.
 2300-3CM 1.5-0-1.5 cm w.c.
 2300-4CM 2-0-2 cm w.c.
 2300-5CM 2.5-0-2.5 cm w.c.
 2300-10CM 5-0-5 cm w.c.
 2300-20CM 10-0-10 cm w.c.
 2300-30CM 15-0-15 cm w.c.
 2300-40CM 20-0-20 cm w.c.
 2300-50CM 25-0-25 cm w.c.
 2300-60CM 30-0-30 cm w.c.
 2300-80CM 40-0-40 cm w.c.
 2300-100CM 50-0-50 cm w.c.
 2000-60NPA 10-0-50 Pa
 2000-30PA 0-30 Pa
 2000-60PA 0-60 Pa
 2000-100PA 0-100 Pa
 2000-125PA 0-125 Pa
 2000-150PA 0-150 Pa
 2000-200PA 0-200 Pa
 2000-250PA 0-250 Pa
 2000-300PA 0-300 Pa
 2000-350PA 0-350 Pa
 2000-400PA 0-400 Pa
 2000-500PA 0-500 Pa
 2000-700PA 0-700 Pa
 2000-750PA 0-750 Pa
 2000-800PA 0-800 Pa
 2000-1000PA 0-1000 Pa



2000-100X10PA	0-100 x 10 Pa	2000-3.5KPA	0-3.5 kPa
2000-1250PA	0-1250 Pa	2000-4KPA	0-4 kPa
2000-125X10PA	0-125 x 10 Pa	2000-5KPA	0-5 kPa
2000-1500PA	0-1500 Pa	2000-6KPA	0-6 kPa
2000-150X10PA	0-150 x 10 Pa	2000-8KPA	0-8 kPa
2000-2000PA	0-2000 Pa	2000-10KPA	0-10 kPa
2000-200X10PA	0-200 x 10 Pa	2000-12KPA	0-12 kPa
2000-2500PA	0-2500 Pa	2000-12.5KPA	0-12.5 kPa
2000-250X10PA	0-250 x 10 Pa	2000-15KPA	0-15 kPa
2000-3000PA	0-3000 Pa	2000-20KPA	0-20 kPa
2000-300X10PA	0-300 x 10 Pa	2000-25KPA	0-25 kPa
2000-4500PA	0-4500 Pa	2000-30KPA	0-30 kPa
2000-450X10PA	0-450 x 10 Pa	2000-35KPA	0-35 kPa
2000-5000PA	0-5000 Pa	2000-40KPA	0-40 kPa
2000-500X10PA	0-500 x 10 Pa	2000-50KPA	0-50 kPa
2000-6000PA	0-6000 Pa	2000-60KPA	0-60 kPa
2000-600X10PA	0-600 x 10 Pa	2000-70KPA	0-70 kPa
2000-8000PA	0-8000 Pa	2000-75KPA	0-75 kPa
2000-800X10PA	0-800 x 10 Pa	2000-80KPA	0-80 kPa
2300-60PA	30-0-30 Pa	2000-100KPA	0-100 kPa
2300-80PA	40-0-40 Pa	2000-140KPA	0-140 kPa
2300-100PA	50-0-50 Pa	2000-170KPA	0-170 kPa
2300-120PA	60-0-60 Pa	2000-200KPA	0-200 kPa
2300-200PA	100-0-100 Pa	2300-0.4KPA	0.2-0-0.2 kPa
2300-250PA	125-0-125 Pa	2300-1KPA	0.5-0-0.5 kPa
2300-300PA	150-0-150 Pa	2300-2KPA	1-0-1 kPa
2300-400PA	200-0-200 Pa	2300-2.5KPA	1.25-0-1.25 kPa
2300-500PA	250-0-250 Pa	2300-3KPA	1.5-0-1.5 kPa
2300-600PA	300-0-300 Pa	2300-4KPA	2-0-2 kPa
2300-1000PA	500-0-500 Pa	2300-5KPA	2.5-0-2.5 kPa
2300-1200PA	600-0-600 Pa	2300-6KPA	3-0-3 kPa
2300-1400PA	700-0-700 Pa	2300-7KPA	3.5-0-3.5 kPa
2300-2000PA	1000-0-1000 Pa	2300-7.5KPA	3.75-0-3.75 kPa
2300-200X10PA	100-0-100 x 10 Pa	2300-8KPA	4-0-4 kPa
2300-3000PA	1500-0-1500 Pa	2300-10KPA	5-0-5 kPa
2300-300X10PA	150-0-150 x 10 Pa	2300-12KPA	6-0-6 kPa
2300-5000PA	2500-0-2500 Pa	2300-16KPA	8-0-8 kPa
2300-500X10PA	250-0-250 x 10 Pa	2300-20KPA	10-0-10 kPa
2300-6000PA	3000-0-3000 Pa	2000-1MBAR	0-1 Millibar
2300-600X10PA	300-0-300 x 10 Pa	2000-1.5MBAR	0-1.5 Millibar
2000-0.1KPA	0-0.1 kPa	2000-2MBAR	0-2 Millibar
2000-0.2KPA	0-0.2 kPa	2000-2.5MBAR	0-2.5 Millibar
2000-0.3KPA	0-0.3 kPa	2000-3MBAR	0-3 Millibar
2000-0.5KPA	0-0.5 kPa	2000-4MBAR	0-4 Millibar
2000-1KPA	0-1 kPa	2000-5MBAR	0-5 Millibar
2000-1.25KPA	0-1.25 kPa	2000-6MBAR	0-6 Millibar
2000-1.5KPA	0-1.5 kPa	2000-8MBAR	0-8 Millibar
2000-2KPA	0-2 kPa	2000-10MBAR	0-10 Millibar
2000-2.5KPA	0-2.5 kPa	2000-12MBAR	0-12 Millibar
2000-3KPA	0-3 kPa	2000-15MBAR	0-15 Millibar



2000-20MBAR 0-20 Millibar
 2000-25MBAR 0-25 Millibar
 2000-30MBAR 0-30 Millibar
 2000-35MBAR 0-35 Millibar
 2000-40MBAR 0-40 Millibar
 2000-50MBAR 0-50 Millibar
 2000-60MBAR 0-60 Millibar
 2000-75MBAR 0-75 Millibar
 2000-80MBAR 0-80 Millibar
 2000-100MBAR 0-100 Millibar
 2000-125MBAR 0-125 Millibar
 2000-150MBAR 0-150 Millibar
 2000-200MBAR 0-200 Millibar
 2000-250MBAR 0-250 Millibar
 2000-300MBAR 0-300 Millibar
 2000-350MBAR 0-350 Millibar
 2000-400MBAR 0-400 Millibar
 2000-500MBAR 0-500 Millibar
 2000-600MBAR 0-600 Millibar
 2000-700MBAR 0-700 Millibar
 2000-800MBAR 0-800 Millibar
 2000-1000MBAR 0-100 x 10 Millibar
 2300-2MBAR 1-0-1 Millibar
 2300-3MBAR 1.5-0-1.5 Millibar
 2300-4MBAR 2-0-2 Millibar
 2300-5MBAR 2.5-0-2.5 Millibar
 2300-6MBAR 3-0-3 Millibar
 2300-10MBAR 5-0-5 Millibar
 2300-20MBAR 10-0-10 Millibar
 2300-24MBAR 12-0-12 Millibar
 2300-30MBAR 15-0-15 Millibar
 2300-50MBAR 25-0-25 Millibar
 2300-60MBAR 30-0-30 Millibar
 2300-70MBAR 35-0-35 Millibar
 2300-80MBAR 40-0-40 Millibar
 2300-100MBAR 50-0-50 Millibar
 2300-500MBAR 250-0-250 Millibar
 2000-0.5ZPSI 0-0.5 ounces per square inch
 2000-1ZPSI 0-1 ounces per square inch
 2000-2ZPSI 0-2 ounces per square inch
 2000-3ZPSI 0-3 ounces per square inch
 2000-4ZPSI 0-4 ounces per square inch
 2000-6ZPSI 0-6 ounces per square inch
 2000-8ZPSI 0-8 ounces per square inch
 2000-10ZPSI 0-10 ounces per square inch
 2000-15ZPSI 0-15 ounces per square inch
 2000-16ZPSI 0-16 ounces per square inch
 2000-20ZPSI 0-20 ounces per square inch
 2000-30ZPSI 0-30 ounces per square inch
 2000-32ZPSI 0-32 ounces per square inch

2000-40ZPSI 0-40 ounces per square inch
 2000-50ZPSI 0-50 ounces per square inch
 2000-80ZPSI 0-80 ounces per square inch
 2000-100ZPSI 0-100 ounces per square inch
 2300-2ZPSI 1-0-1 ounces per square inch
 2000-0.1BAR 0-0.10 Bar
 2000-0.2BAR 0-0.20 Bar
 2000-0.5BAR 0-0.5 Bar
 2000-1BAR 0-1 Bar
 2000-1.5BAR 0-1.5 Bar
 2000-2BAR 0-2 Bar
 2300-0.1BAR 0.05-0-0.05 Bar
 2000-0.5KG 0-0.5 KG/CM2
 2000-1KG 0-1 KG/CM2
 2000-1.5KG 0-1.5 KG/CM2
 2000-2KG 0-2 KG/CM2



Con opzione VF

2000-10VF1 0-10" w.c. & 0-20 SCFM air (w/1" NPT Tube)
2000-10VF2 0-10" w.c. & 0-50 SCFM air (w/1.5" NPT Tube)
2000-10VF3 0-10" w.c. & 0-85 SCFM air (w/2" NPT Tube)
2000-10VF4 0-10" w.c. & 0-200 SCFM air (w/3" NPT Tube)
2000-10VF5 0-10" w.c. & 0-350 SCFM air (w/4" NPT Tube)
2000-20VF1 0-20" w.c. & 0-30 SCFM air (w/1" NPT Tube)
2000-20VF2 0-20" w.c. & 0-70 SCFM air (w/1.5" NPT Tube)
2000-20VF3 0-20" w.c. & 0-120 SCFM air (w/2" NPT Tube)
2000-20VF4 0-20" w.c. & 0-290 SCFM air (w/3" NPT Tube)
2000-20VF5 0-20" w.c. & 0-500 SCFM air (w/4" NPT Tube)
2000-40VF1 0-40" w.c. & 0-40 SCFM air (w/1" NPT Tube)
2000-40VF2 0-40" w.c. & 0-100 SCFM air (w/1.5" NPT Tube)
2000-40VF3 0-40" w.c. & 0-160 SCFM air (w/2" NPT Tube)
2000-40VF4 0-40" w.c. & 0-395 SCFM air (w/3" NPT Tube)
2000-40VF5 0-40" w.c. & 0-675 SCFM air (w/4" NPT Tube)