

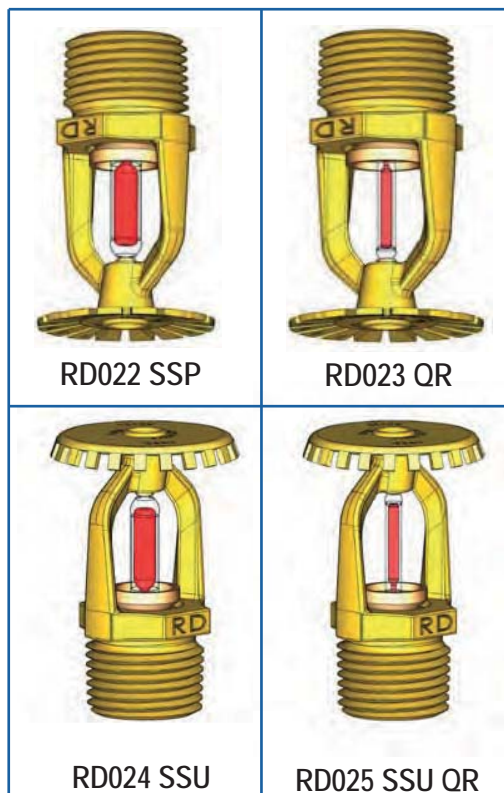

15mm (1/2") Upright/Pendant Sprinklers Model: RD022/ RD023/ RD024/ RD025 Standard/Quick Response with 5mm/3mm Glass Bulbs K5.6(80), 1/2" Pipe Thread

Product Description

RD022/ RD023/ RD024/ RD025 Upright/Pendant are Standard/Quick Response frangible glass bulb automatic sprinklers. They are CE marked, LPCB, FM and VdS approved, UL listed, standard orifice fire sprinklers for installation in fire sprinkler systems. Designed in accordance with standard installation rules, e.g. NFPA13, EN12845 or the requirements of the authority having jurisdiction. Upright sprinklers produce a hemispherical water distribution pattern below the deflector. In a fire condition the heat causes the fluid in the glass bulb to expand which shatters the glass and releases the spring seal assembly. Water flows from the orifice onto the sprinkler deflector which diffuses the water into a uniform spray pattern which extinguishes or controls the fire.



Standard Response – RD022 & RD024

Nominal Operating Temperatures:	Bulb Colour:
135°F (57°C)	Orange
155°F (68°C)	Red
175°F (79°C)	Yellow
200°F (93°C)	Green
286°F (141°C)	Blue

Quick Response – RD023 & RD025

Nominal Operating Temperatures:	Bulb Colour:
135°F (57°C)	Orange
155°F (68°C)	Red
175°F (79°C)	Yellow
200°F (93°C)	Green
286°F (141°C)	Blue

Technical Details:

Standard Orifice Size: 1/2" (15mm)
 K factor: 80 (5.6)
 Standard Thread Size: 1/2"NPT
 (R1/2 – 1/2"BSPT available on special order)
 Maximum Working Pressure: 175psi (12bar)
 Factory Pressure Test: 100% at 500psi (34bar)
 Weight: 2oz. (57grams).
 Fitted with bulb protector.
 (Remove after installing sprinkler)

Standard Finishes:

Plain (Natural)
 Chrome
 Epoxy Powder Polyester - White
 (Other RAL colours available on special order)

Accessories:

Single Piece Escutcheon (Rosette)
 Adjustable Escutcheon (Rosette)
 Sprinkler Guard
 Series 20 Sprinkler Wrench

Continued Overleaf
Page 1 of 3



Ref. 566/d

EN 12259-1



Rapidrop Global

Design Coverage:

For sprinkler coverage area and placement refer to NFPA 13 standards or other Installation rules for automatic sprinkler systems as required by the authority having jurisdiction. The following details are provided for information only.

RD022 & RD023

Spray Pendent for installing only in pendent position giving hemispherical discharge below the deflector with little or no water being discharged upwards

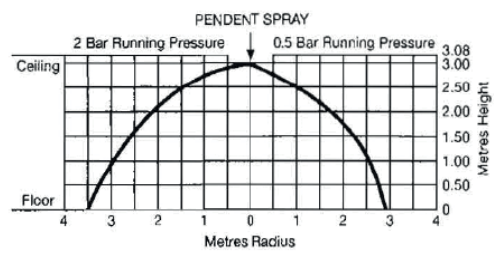

RD024 & RD025

Spray Upright for installing only in upright position giving hemispherical discharge below the deflector with little or no water being discharged upwards.

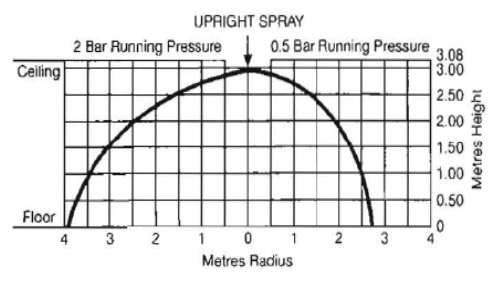

Minimum Operating Pressure = 7psig (0.5 Bars)
Flow Characteristics

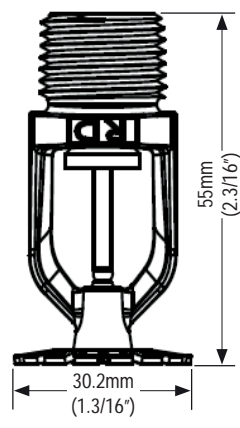
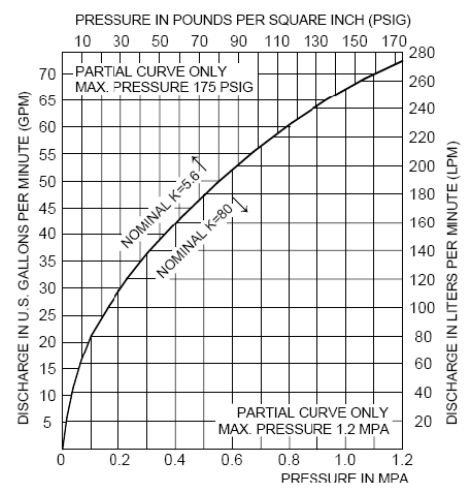

RD022 & RD023
SSP & QR SSP
Figure A

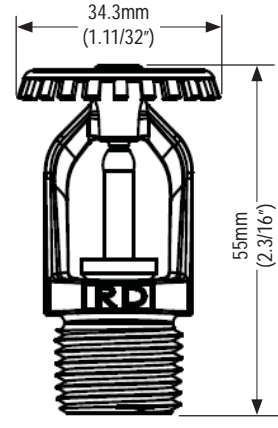

RD024 & RD025
SSU & QR SSU
Figure B

* Bulb sizes shown for reference only.



Installation:

1. All Rapidrop sprinklers must be installed and maintained in compliance with this document and according to the installation standards, EN 12845, or local rules and requirements which are specified by the authority having jurisdiction. It is the installer's responsibility to conform to such standards and requirements, deviations from the requirements will void any warranty.
2. To ensure that the minimum flow requirement is met, the system piping must be correctly sized.
3. To avoid mechanical damage the sprinklers must be installed after the piping is in place. Any damaged sprinklers must be replaced. If there is a leak from the sprinkler thread, remove the sprinkler, apply new pipe joint compound or tape and re-install.
4. Always check that the sprinklers are the correct model, style, orifice size, temperature and sensitivity ratings prior to commencing installation.
5. Upright sprinklers must be mounted in upright position and Pendent sprinklers must be mounted in pendent position.
6. Use only non-hardening pipe joint compound or 'Teflon' tape. Apply to external threads only.
7. Hand tighten the sprinkler into the fitting, then use the correct sprinkler wrench (Rapidrop Series 20 – See Figure C) to tighten the sprinkler into the fitting. Ensure that the sprinkler wrench stays on the wrench flats while tightening the sprinkler. A leak tight joint requires only 9.5 to 19 Nm (7 to 14 ft.lbs.) torque. i.e. A tangential force of 6.35 to 12.7kgs. (14 to 28 lbs.) delivered through a 150mm (6") handle will deliver adequate torque. Torque levels over 29Nm (21 ft.lbs.) may distort the orifice seal and result in leakage.
8. Remove sprinkler bulb protector before the sprinkler system is put into service.

Care and Maintenance:

Sprinklers must be carefully handled and stored where temperatures will not exceed 100°F/38°C and they must never be painted, plated, coated or otherwise modified after leaving the factory.

Do not install sprinklers which have been dropped or damaged in any way.

The installation rules required by the authority having jurisdiction contain guidelines on minimum inspection and maintenance requirements to assist owners fulfilling their responsibility to ensure sprinklers and sprinkler systems are maintained in proper operating condition.

Warranty:

Warranty period is one year from the date of shipment. For full details please refer to our terms and conditions of sale.

Ordering Information:

Specify: model, orifice size, style, temperature, response, finish and approval listing required. Always order and use a Series 20 Wrench for installing these sprinklers.

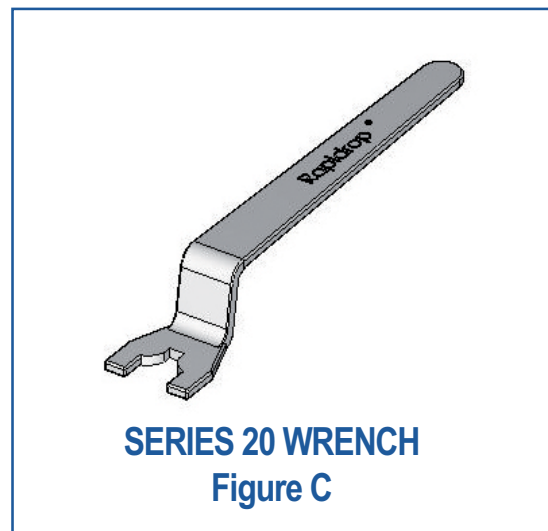

Ref. 566/d

EN 12259-1

