

High Velocity Water Spray Nozzle

Ref: SPTDHV/E	
Issue B Jan, 2011	Technical Data

TECHNICAL DATA

MODEL	HV-AS with strainer	
MAXIMUM WORKING PRESSURE	12 Bar (175 PSI)	
EFFECTIVE WORKING PRESSURE	3.5 Bar to 10.5 Bar (50 - 150 PSI)	
END CONNECTION	3/4" BSPT (3/4" NPT OPTIONAL)	
MATERIAL	Housing & Scroll - Brass IS : 291 (EQUIVALENT TO ASTM-B21) Strainer - Copper	
INCLUDED WATER SPRAY ANGLE AND K-FACTOR	SPRAY ANGLE	K-FACTOR METRIC (US)
	75°	- 22 (1.54)
	80°	- 18 (1.26)
	90°	- 32 (2.24)
	100°	- 26 (1.82)
	115°	- 42 (2.94)
	120°	- 23 (1.61)
WEIGHT (Approx)	0.200 Kg	
FINISH	Brass Finish Nickel Chrome Plated (optional)	
APPROVALS	UL Listed	
ORDERING INFORMATION	Specify Model, K-Factor, Spray angle and Finish	



any affecting the spray pattern of the nozzle must be considered. The nozzle may be oriented in any position as deemed necessary to cover the hazard.

3.5 bar to 7 bar pressure at Nozzle is recommended for effective application requiring High Velocity Water delivery for rapid extinguishment of all fires by emulsification.

The Nozzles are having inbuilt Strainer, but still main pipeline strainer is required in the system.

The Blow-off cap can be used to prevent the depositing of foreign material in the water way of the nozzle. Use of Blow-off cap is optional and not UL listed.

DESCRIPTION

High Velocity Water Spray Nozzles are internal swirl plate type open nozzles designed for use in fixed water spray or deluge system for the fire protection application.

These nozzles produce solid uniform and dense core of high velocity water spray to effect fire control. Nozzles are normally used to cool the surface as well as for extinguishment. Nozzles are typically used for Deluge protection of special hazards such as oil filled transformers, switch-gear, chemical process equipments, conveyor system and flammable liquid storage areas. The minimum desirable pressure to achieve a reasonable spray pattern is 3.5 Kg./sq.cm. (50 psi). The water distribution pattern is as shown in the graph in following pages giving maximum effective axial distance from the nozzle. The spray pattern shown is with indoor application. The system designer must consider wind velocity while designing the system for outdoor application. Field obstruction if

MAINTENANCE

The spray nozzle must be handled with due care. For best results, the storage as well as any further shipment be made in original packing only.

Nozzle which is visibly damaged should not be installed. Use Teflon tape or soft thread sealant on the male thread of the nozzle.

It is recommended that the water spray system be inspected by an authorised technical personnel. The nozzle must be checked for corrosion, external and internal obstruction, blockage if any. The nozzle should be cleaned or replaced if required. The system must be operated with optimum water flow at least three times in a year or as per the provision of NFPA/TAC or local authority having jurisdiction.

The owner is solely responsible for maintaining the water spray system and components therein, so that it performs properly when required.

High Velocity Water Spray Nozzle

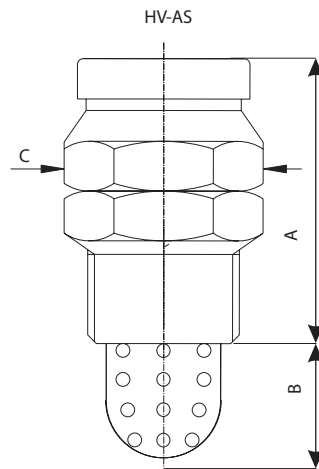

Ref: SPTDHV/E	
Issue B Jan, 2011	Technical Data

DIMENSION In millimeters (Approximate)

NOZZLE FACTOR & SPRAY ANGLE	A	B	C A/F
K 22 x 75°	49	21	30
K 18 x 80°	44	21	30
K 32 x 90°	49	21	30
K 26 x 100°	55	21	30
K 23 x 120°	49	21	30
K 42 x 115°	49	21	30

DISCHARGE CHARACTERISTICS

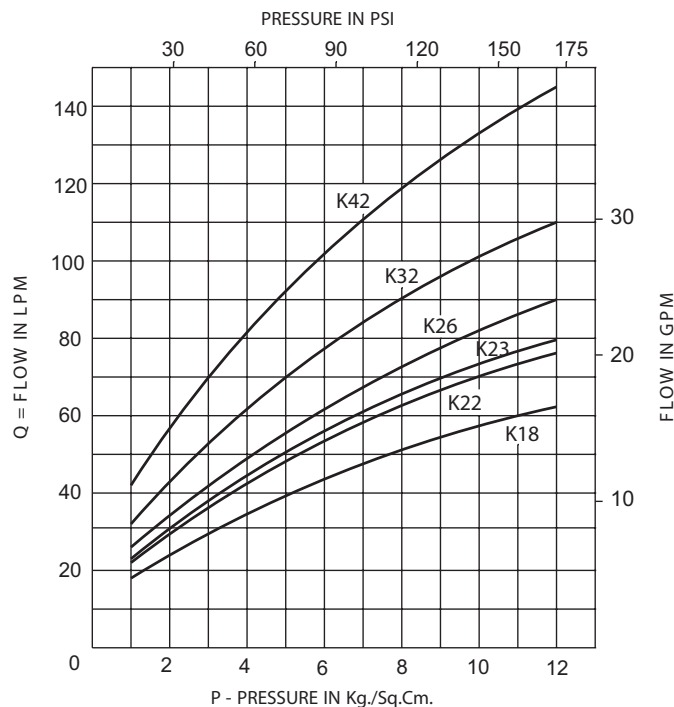

$Q = K\sqrt{P}$ where P is supply pressure in Kg/sq.cm., K= nozzle constant (K-factor) in metric
US K factor = Metric K factor \div 14.2745

High Velocity Water Spray Nozzle

SPRAY PATTERN

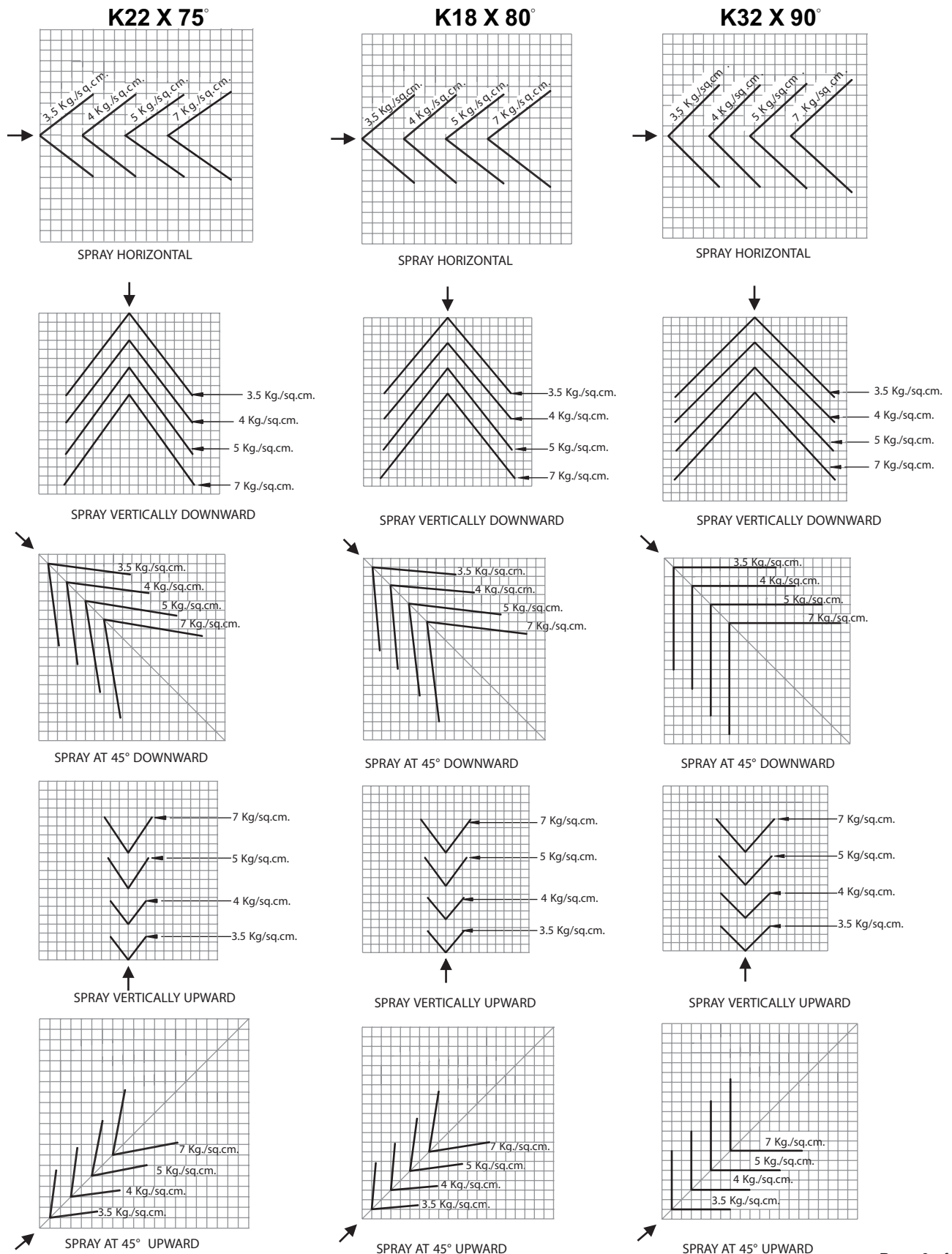

Note : One square is 200 X 200 mm.

High Velocity Water Spray Nozzle

SPRAY PATTERN

K42 X 115°

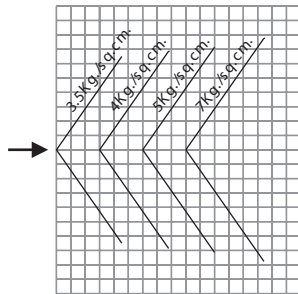

SPRAY HORIZONTAL

K23 X 120°

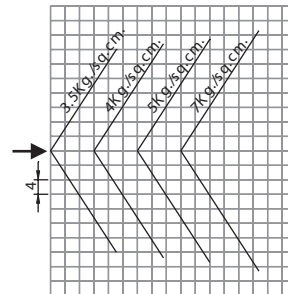

SPRAY HORIZONTAL

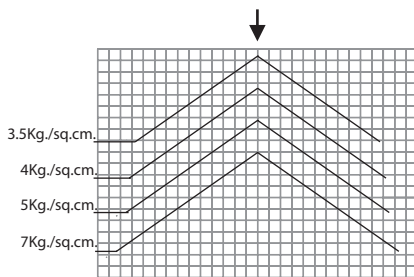

SPRAY VERTICALLY DOWNWARD

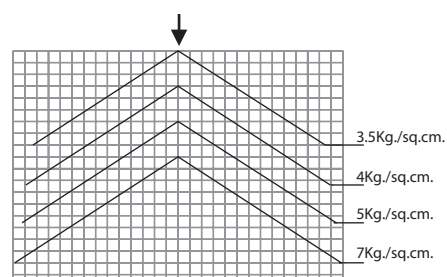

SPRAY VERTICALLY DOWNWARD

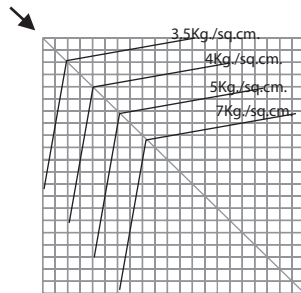

SPRAY AT 45° DOWNWARD

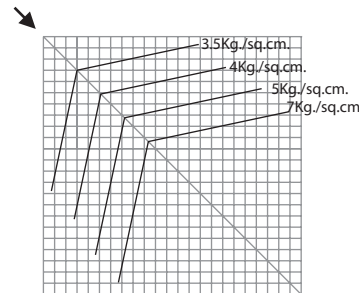

SPRAY AT 45° DOWNWARD

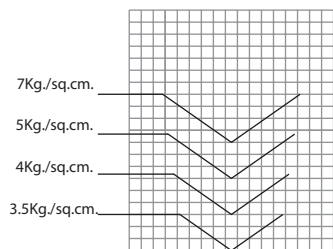

SPRAY VERTICALLY UPWARD

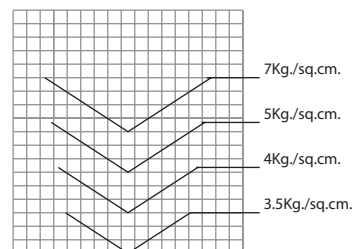

SPRAY VERTICALLY UPWARD

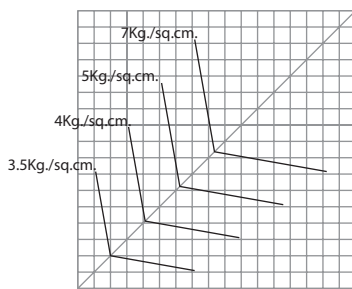

SPRAY AT 45° UPWARD

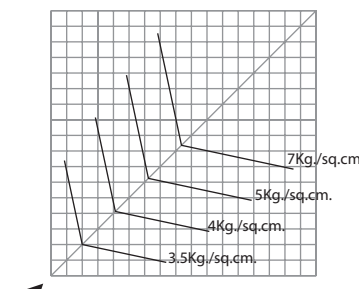

SPRAY AT 45° UPWARD

Note : One square is 200 X 200 mm.



High Velocity Water Spray Nozzle

SPRAY PATTERN

K26 X 100°

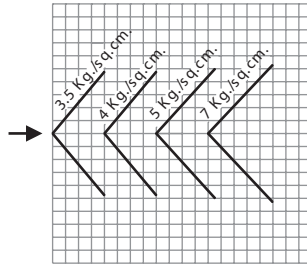

SPRAY HORIZONTAL

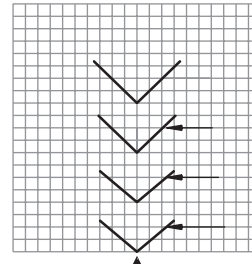

SPRAY VERTICALLY UPWARD

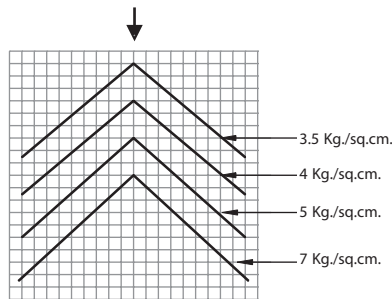

SPRAY VERTICALLY DOWNWARD

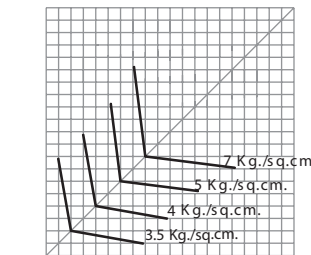

SPRAY AT 45° UPWARD

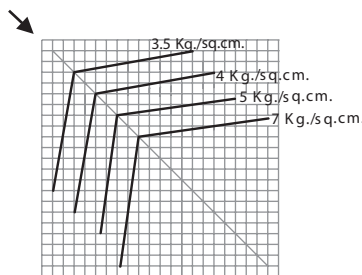

SPRAY AT 45° DOWNWARD

Note : One square is 200 X 200 mm.

LIMITED WARRANTY

Products supplied by Rapidrop (RD) are warranted against defects in material and workmanship for a period of Two (2) years from the date of shipment. RD's obligation under this warranty is limited to replace or repair the products or its parts, which are shown to RD's examination to be in a defective condition attributable to RD. No warranty is given for products or components which have been subject, to misuse, improper installation, corrosion, wear and tear, improper storage, modification or repaired. If the defect attributable to RD cannot be rectified by repair or replacement, then RD may elect to refund the purchase price of the equipment in complete discharge of its obligation under this Limited Warranty.

IN NO EVENT SHALL RAPIDROP BE LIABLE IN CONTRACT, STRICT LIABILITY OR ANY OTHER LEGAL THEORY, FOR INCIDENTAL, IN-DIRECT, SPECIAL OR CONSEQUENTIAL DAMAGES, INCLUDING DAMAGES. FOR INJURY TO PERSON OR DEATH OR DAMAGE TO PROPERTY AND OR PENALTIES RESULTING FROM ANY PRODUCTS OR COMPONENT MANUFACTURED OR ASSEMBLED BY RD. THIS IS LIMITED WARRANTY ONLY. RD DISCLAIMS WITH RESPECT TO THE PRODUCTS ALL IMPLIED WARRANTIES OF MERCHANTABILITY AND ALL IMPLIED WARRANTIES OF FITNESS FOR A PARTICULAR PURPOSE. THERE IS NO WARRANTY OF ANY NATURE MADE BY RD BEYOND AS STATED ABOVE.

NOTICE :

The equipment presented in this bulletin is to be installed in accordance with the latest publication standards of NFPA or other similar organisations and also with the provision of government codes or ordinances wherever applicable. The information provided by us are to the best of our knowledge and belief, and are general guidelines only. Site handling and installation control is beyond our reach. Hence we give no guarantee for result and take no liability for damages, loss or penalties whatsoever, resulting from our suggestion, information, recommendation or damages due to our product. Product development is a continuous programme of RAPIDROP and hence the right to modify any specification without prior notice is reserved with the company.

