

# Quick-connects

QC, QF and QV Series



[www.finelok.com](http://www.finelok.com)

# Contents

QC Series  01

QF Series  09

QV Series  13

## QC Series

### Features

- ★ Maximum working pressure: 3000 psig (207 bar)
- ★ Working temperatures:
  - 10°F to 400°F (-23°C to 204°C) with Fluorocarbon FKM seal
  - 10°F to 250°F (-23°C to 121°C) with Buna N seal
- ★ Materials: stainless steel or brass
- ★ Reliable, leak-tight O-ring seal for vacuum or pressure systems.
- ★ Interchangeable with other main brands.
- ★ Single-end shutoff, double-end shutoff, and full-flow available.

### Single-end Shutoff (SESO)

SESO stem + body

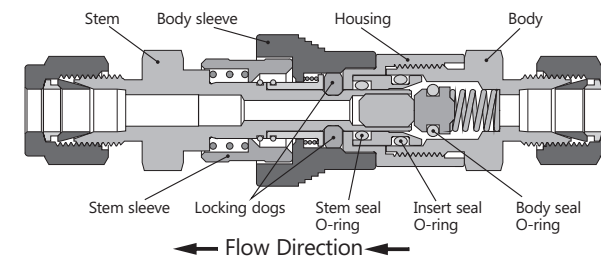

### Double-end Shutoff (DESO)

DESO stem + body

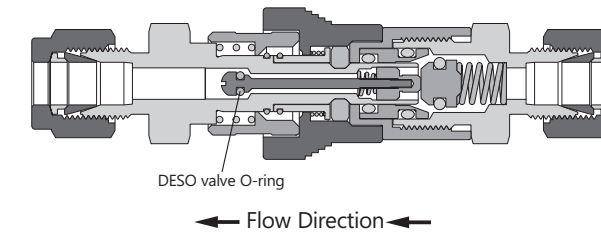

### Full-flow Quick-connects

SESO stem + full-flow body

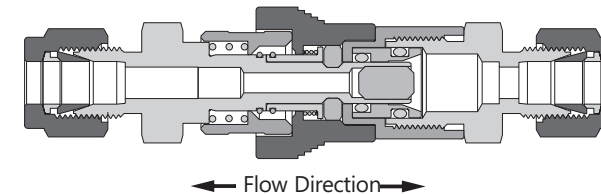

### Cautions:

- ★ Do not uncouple single-end shutoff quick-connects under pressure.
- ★ Do not insert foreign object into uncoupled stems and bodies.
- ★ Re-lubricate stem seal O-ring periodically.

- ★ Simple push-to-connect coupling for quick and easy operation.
- ★ Sturdy locking mechanism with large contact area to ensure reliable stem retainment.



### Standard Materials of Construction

Component	Material	
	316 SS	Brass
Body, housing, stem, body valve, body insert, DESO valve, DESO retainer	316 SS	Brass C36000
SESO stem insert		Brass C26000
O-rings	Fluorocarbon FKM	Buna N
Springs	316 SS	
Snap rings	316 SS	
Body sleeve	Powdered metal 300 series SS	Brass C36000
DESO stem sleeve	Polyurethane enamelcoated 316 SS	Polyurethane enamelcoated brass C36000
SESO stem sleeve	316 SS	Brass C36000
Locking dogs	Xylan®-coated 316 SS powdered metal	
Lubricants	Silicone- and PTFE-based	

### Pressure-Temperature Ratings

Temperature °F (°C)	Stainless Steel with FKM O-ring			Brass with Buna N O-ring		
	QC4	QC6	QC8	QC4	QC6	QC8
	pressure rating, psig (bar)					
-10~70 (-23~20)	3000 (206)	1500 (103)	750 (51.6)	2000 (137)	1000 (68.9)	500 (34.4)
250 (121)	—			250 (17.2)		
400 (204)	250 (17.2)			—		

### Insertion Depth and Maximum Flow Rate

Series	Insertion Depth		Max. Flow Rate at 70°F (20°C)	
	SESO	DESO	U.S. gal/min	L/min
	in. (mm)	in. (mm)		
QC4	1.09 (27.7)	1.15 (29.2)	4.0	15.0
QC6	1.18 (30.0)	1.30 (33.0)	6.0	22.0
QC8	1.48 (37.6)	1.68 (42.7)	10.0	37.0

In order to measure overall length in the coupled position, the insertion depth should be deducted from any overall stem and body combination length.

Dimensions

SESO Stems

Tube Fitting

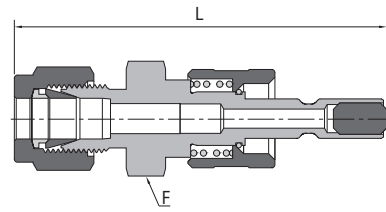

Tube Size	Basic Ordering Number	Flow Coefficient (Cv)	F	L
in.			in.	in. (mm)
1/8	-QC4-S2-S	0.08	5/8	2.32 (58.9)
1/4	-QC4-S4-S	0.3	5/8	2.36 (59.9)
3/8	-QC6-S6-S	1.0	3/4	2.52 (64.0)
1/2	-QC8-S8-S	2.4	15/16	2.96 (75.2)
mm			mm	mm (in.)
6	-QC4-SM6-S	0.3	16	59.9 (2.36)
10	-QC6-SM10-S	1.0	19	67.3 (2.65)
12	-QC8-SM12-S	2.4	24	75.2 (2.96)

Male NPT

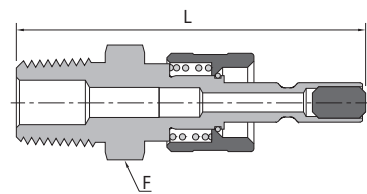

NPT Size	Basic Ordering Number	Flow Coefficient (Cv)	F	L
			in.	in. (mm)
1/8	-QC4-NT2-S	0.3	5/8	2.07 (52.6)
1/4	-QC4-NT4-S	0.3	5/8	2.22 (56.4)
1/4	-QC6-NT4-S	0.8	3/4	2.32 (58.9)
3/8	-QC6-NT6-S	0.8	3/4	2.35 (59.7)
1/2	-QC8-NT8-S	2.0	15/16	2.84 (72.1)

Female NPT

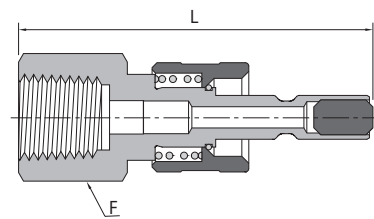

NPT Size	Basic Ordering Number	Flow Coefficient (Cv)	F	L
			in.	in. (mm)
1/8	-QC4-FNT2-S	0.3	5/8	2.01 (51.1)
1/4	-QC4-FNT4-S	0.3	3/4	2.26 (57.4)
1/4	-QC6-FNT4-S	0.8	3/4	2.35 (59.7)
3/8	-QC6-FNT6-S	0.8	7/8	2.35 (59.7)
1/2	-QC8-FNT8-S	2.0	1 1/16	2.82 (71.6)

Male BSPT

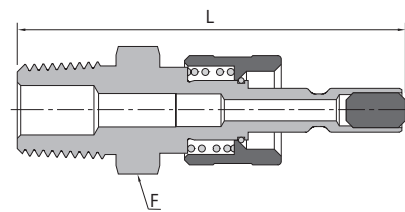

BSPT Size	Basic Ordering Number	Flow Coefficient (Cv)	F	L
			in.	in. (mm)
1/8	-QC4-RT2-S	0.3	5/8	2.07 (52.6)
1/4	-QC4-RT4-S	0.3	5/8	2.22 (56.4)
1/4	-QC6-RT4-S	0.8	3/4	2.32 (58.9)
3/8	-QC6-RT6-S	0.8	3/4	2.35 (59.7)
1/2	-QC8-RT8-S	2.0	15/16	2.84 (72.1)

Female BSPT

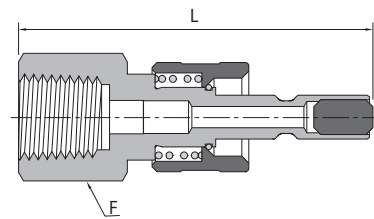

BSPT Size	Basic Ordering Number	Flow Coefficient (Cv)	F	L
			in.	in. (mm)
1/8	-QC4-FRT2-S	0.3	5/8	2.01 (51.1)
1/4	-QC4-FRT4-S	0.3	3/4	2.26 (57.4)
1/4	-QC6-FRT4-S	0.8	3/4	2.35 (59.7)
3/8	-QC6-FRT6-S	0.8	7/8	2.35 (59.7)
1/2	-QC8-FRT8-S	2.0	1 1/16	2.82 (71.6)

Male JIC(AN) 37° Flare

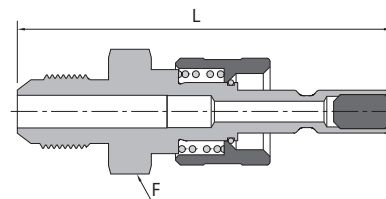

AN Tube Flare Size	Basic Ordering Number	Flow Coefficient (Cv)	F	L
in.			in.	in. (mm)
1/4	-QC4-AN4-S	0.2	5/8	2.23 (56.6)
3/8	-QC6-AN6-S	1.0	3/4	2.35 (59.7)
1/2	-QC8-AN8-S	2.4	15/16	2.79 (70.9)

SESO Stems

Hose Connector

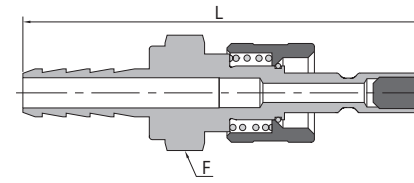

Hose Size	Basic Ordering Number	Flow Coefficient (Cv)	F	L
in.			in.	in. (mm)
1/4	-QC4-HC4-S	0.2	5/8	2.47 (62.7)
3/8	-QC6-HC6-S	1.0	3/4	2.66 (67.6)
1/2	-QC8-HC8-S	2.4	15/16	3.07 (78.0)

Bulkhead Tube Fitting

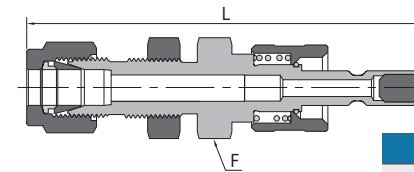

Tube Size	Basic Ordering Number	Flow Coefficient (Cv)	F	L	Min. Panel Hole	Max. Panel Thickness
in.			in.	in. (mm)	in. (mm)	in. (mm)
1/4	-QC4-BS4-S	0.3	5/8	2.74 (69.6)	0.47 (11.9)	0.25 (6.4)
3/8	-QC6-BS6-S	1.0	3/4	2.92 (74.2)	0.60 (15.2)	0.27 (6.9)
1/2	-QC8-BS8-S	2.4	15/16	3.43 (87.1)	0.78 (19.8)	0.26 (6.6)
mm			mm	mm (in.)	mm (in.)	mm (in.)
6	-QC4-BSM6-S	0.3	16	69.6 (2.74)	11.7 (0.46)	6.4 (0.25)
10	-QC6-BSM10-S	1.0	22	77.7 (3.06)	16.8 (0.66)	6.9 (0.27)
12	-QC8-BSM12-S	2.4	24	87.1 (3.43)	19.6 (0.77)	6.6 (0.26)

DESO Stems

Tube Fitting

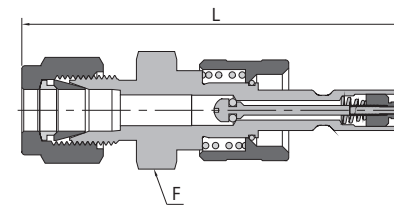

Tube Size	Basic Ordering Number	Flow Coefficient (Cv)	F	L
in.			in.	in. (mm)
1/8	-QC4-S2-D	0.08	5/8	2.77 (70.4)
1/4	-QC4-S4-D	0.2	5/8	2.42 (61.5)
3/8	-QC6-S6-D	0.5	3/4	2.64 (67.1)
1/2	-QC8-S8-D	1.5	15/16	3.16 (80.3)
mm			mm	mm (in.)
6	-QC4-SM6-D	0.2	16	61.5 (2.42)
10	-QC6-SM10-D	0.5	19	70.4 (2.77)
12	-QC8-SM12-D	1.5	24	80.3 (3.16)

Male NPT

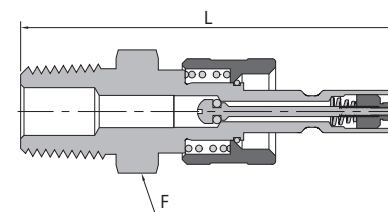

NPT Size	Basic Ordering Number	Flow Coefficient (Cv)	F	L
			in.	in. (mm)
1/8	-QC4-NT2-D	0.2	5/8	2.13 (54.1)
1/4	-QC4-NT4-D	0.2	5/8	2.28 (57.8)
1/4	-QC6-NT4-D	0.5	3/4	2.44 (61.9)
3/8	-QC6-NT6-D	0.5	3/4	2.47 (62.7)
1/2	-QC8-NT8-D	1.3	15/16	3.04 (77.2)

Female NPT

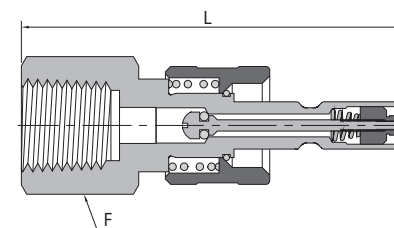

NPT Size	Basic Ordering Number	Flow Coefficient (Cv)	F	L
			in.	in. (mm)
1/8	-QC4-FNT2-D	0.2	5/8	2.07 (52.6)
1/4	-QC4-FNT4-D	0.2	3/4	2.32 (58.9)
1/4	-QC6-FNT4-D	0.5	3/4	2.47 (62.7)
3/8	-QC6-FNT6-D	0.5	7/8	2.47 (62.7)
1/2	-QC8-FNT8-D	1.3	1 1/16	3.04 (77.2)

DESO Stems

Male BSPT

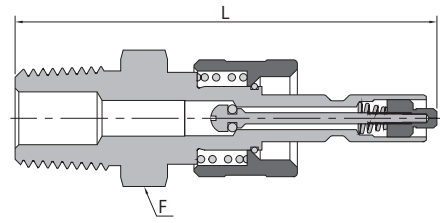

BSPT Size	Basic Ordering Number	Flow Coefficient (Cv)	F		L	
			in.	in. (mm)	in.	in. (mm)
1/8	-QC4-RT2-D	0.2	5/8	2.13 (54.1)		
1/4	-QC4-RT4-D	0.2	5/8	2.28 (57.8)		
1/4	-QC6-RT4-D	0.5	3/4	2.44 (61.9)		
3/8	-QC6-RT6-D	0.5	3/4	2.47 (62.7)		
1/2	-QC8-RT8-D	1.3	15/16	3.04 (77.2)		

Female BSPT

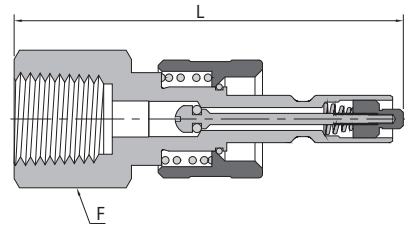

BSPT Size	Basic Ordering Number	Flow Coefficient (Cv)	F		L	
			in.	in. (mm)	in.	in. (mm)
1/8	-QC4-FRT2-D	0.2	5/8	2.07 (52.6)		
1/4	-QC4-FRT4-D	0.2	3/4	2.32 (58.9)		
1/4	-QC6-FRT4-D	0.5	3/4	2.47 (62.7)		
3/8	-QC6-FRT6-D	0.5	7/8	2.47 (62.7)		
1/2	-QC8-FRT8-D	1.3	1 1/16	3.04 (77.2)		

Male JIC(AN) 37° Flare

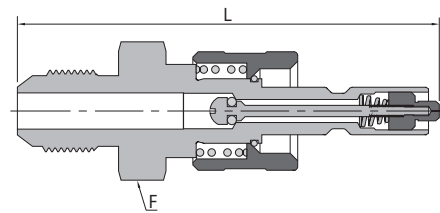

AN Tube Flare Size in.	Basic Ordering Number	Flow Coefficient (Cv)	F		L	
			in.	in. (mm)	in.	in. (mm)
1/4	-QC4-AN4-D	0.2	5/8	2.29 (58.2)		
3/8	-QC6-AN6-D	0.5	3/4	2.47 (62.7)		
1/2	-QC8-AN8-D	1.5	15/16	2.99 (75.9)		

Hose Connector

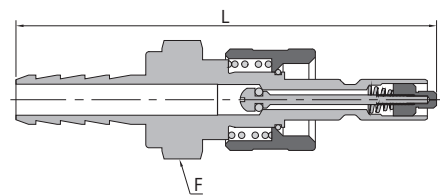

Hose Size in.	Basic Ordering Number	Flow Coefficient (Cv)	F		L	
			in.	in. (mm)	in.	in. (mm)
1/4	-QC4-HC4-D	0.2	5/8	2.53 (64.3)		
3/8	-QC6-HC6-D	0.5	3/4	2.78 (70.6)		
1/2	-QC8-HC8-D	1.5	15/16	3.27 (83.1)		

Bulkhead Tube Fitting

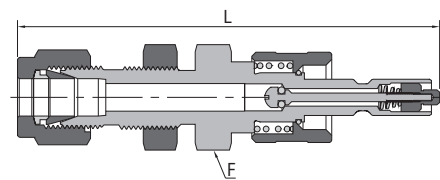

Tube Size in.	Basic Ordering Number	Flow Coefficient (Cv)	F		L		Min. Panel Hole in. (mm)	Max. Panel Thickness in. (mm)
			in.	in. (mm)	in.	in. (mm)		
1/4	-QC4-BS4-D	0.2	5/8	2.80 (71.1)	0.47 (11.9)	0.25 (6.4)		
3/8	-QC6-BS6-D	0.5	3/4	3.07 (78.0)	0.60 (15.2)	0.27 (6.9)		
1/2	-QC8-BS8-D	1.5	15/16	3.63 (92.2)	0.78 (19.8)	0.26 (6.6)		
mm			mm	mm (in.)	mm (in.)	mm (in.)		
6	-QC4-BSM6-D	0.2	16	71.1 (2.80)	11.7 (0.46)	6.4 (0.25)		
10	-QC6-BSM10-D	0.5	22	78.7 (3.10)	16.8 (0.66)	6.9 (0.27)		
12	-QC8-BSM12-D	1.5	24	92.2 (3.63)	19.6 (0.77)	6.6 (0.26)		

Bodies

Tube Fitting

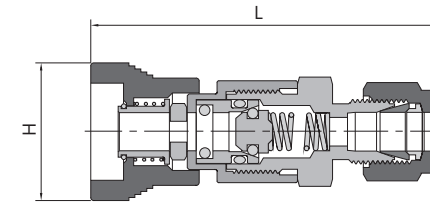

Male NPT

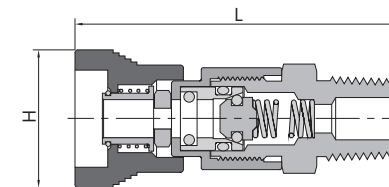

Female NPT

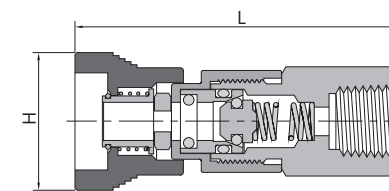

Male BSPT

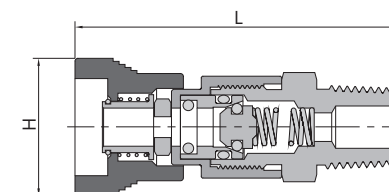

Female BSPT

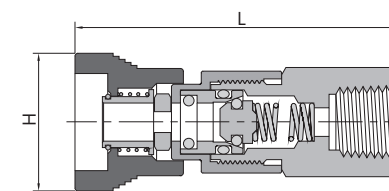

Male JIC (AN) 37° Flare

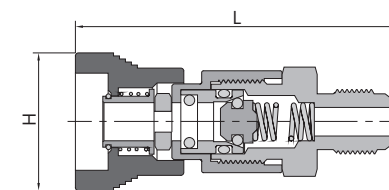

Tube Size in.	Basic Ordering Number	H		L	
		in. (mm)	in. (mm)	in.	in. (mm)
1/8	-QC4-S2-B	0.91 (23.1)	2.26 (57.4)		
1/4	-QC4-S4-B	0.91 (23.1)	2.30 (58.4)		
3/8	-QC6-S6-B	1.03 (26.2)	2.58 (65.5)		
1/2	-QC8-S8-B	1.21 (30.7)	3.09 (78.5)		
mm		mm (in.)	mm (in.)		
6	-QC4-SM6-B	23.1 (0.91)	58.4 (2.30)		
10	-QC6-SM10-B	26.2 (1.03)	68.1 (2.68)		
12	-QC8-SM12-B	30.7 (1.21)	78.5 (3.09)		

NPT Size	Basic Ordering Number	H		L	
		in. (mm)	in. (mm)	in.	in. (mm)
1/8	-QC4-NT2-B	0.91 (23.1)	2.01 (51.1)		
1/4	-QC4-NT4-B	0.91 (23.1)	2.16 (54.9)		
1/4	-QC6-NT4-B	1.03 (26.2)	2.38 (60.5)		
3/8	-QC6-NT6-B	1.03 (26.2)	2.38 (60.5)		
1/2	-QC8-NT8-B	1.21 (30.7)	2.97 (75.4)		

NPT Size	Basic Ordering Number	H		L	
		in. (mm)	in. (mm)	in.	in. (mm)
1/8	-QC4-FNT2-B	0.91 (23.1)	2.16 (54.9)		
1/4	-QC4-FNT4-B	0.91 (23.1)	2.42 (61.5)		
1/4	-QC6-FNT4-B	1.03 (26.2)	2.54 (64.5)		
3/8	-QC6-FNT6-B	1.03 (26.2)	2.57 (65.3)		
1/2	-QC8-FNT8-B	1.21 (30.7)	3.22 (81.8)		

BSPT Size	Basic Ordering Number	H		L	
		in. (mm)	in. (mm)	in.	in. (mm)
1/8	-QC4-RT2-B	0.91 (23.1)	2.01 (51.1)		
1/4	-QC4-RT4-B	0.91 (23.1)	2.16 (54.9)		
1/4	-QC6-RT4-B	1.03 (26.2)	2.38 (60.5)		
3/8	-QC6-RT6-B	1.03 (26.2)	2.38 (60.5)		
1/2	-QC8-RT8-B	1.21 (30.7)	2.97 (75.4)		

BSPT Size	Basic Ordering Number	H		L	
		in. (mm)	in. (mm)	in.	in. (mm)
1/8	-QC4-FRT2-B	0.91 (23.1)	2.16 (54.9)		
1/4	-QC4-FRT4-B	0.91 (23.1)	2.42 (61.5)		
1/4	-QC6-FRT4-B	1.03 (26.2)	2.54 (64.5)		
3/8	-QC6-FRT6-B	1.03 (26.2)	2.57 (65.3)		
1/2	-QC8-FRT8-B	1.21 (30.7)	3.22 (81.8)		

AN Tube Flare Size in.	Basic Ordering Number	H		L	
		in. (mm)	in. (mm)	in.	in. (mm)
1/4	-QC4-AN4-B	0.91 (23.1)	2.17 (55.1)		
3/8	-QC6-AN6-B	1.03 (26.2)	2.41 (61.2)		
1/2	-QC8-AN8-B	1.21 (30.7)	2.92 (74.2)		



Bodies

Hose Connector

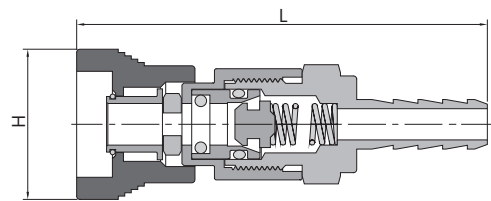

Hose Size	Basic Ordering Number	H	L
in.		in. (mm)	in. (mm)
1/4	-QC4-HC4-B	0.91 (23.1)	2.41 (61.2)
3/8	-QC6-HC6-B	1.03 (26.2)	2.72 (69.1)
1/2	-QC8-HC8-B	1.21 (30.7)	3.20 (81.3)

Bulkhead Tube Fitting

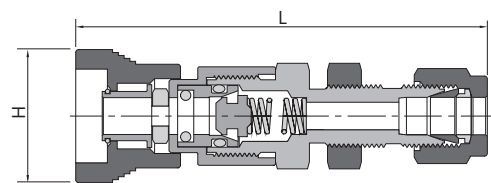

Tube Size	Basic Ordering Number	H	L	Min. Panel Hole	Max. Panel Thickness
in.		in. (mm)	in. (mm)	in. (mm)	in. (mm)
1/4	-QC4-BS4-B	0.91 (23.1)	2.67 (67.8)	0.47 (11.9)	0.25 (6.4)
3/8	-QC6-BS6-B	1.03 (26.2)	2.98 (75.7)	0.60 (15.2)	0.27 (6.9)
1/2	-QC8-BS8-B	1.21 (30.7)	3.56 (90.4)	0.78 (19.8)	0.26 (6.6)
mm		mm (in.)	mm (in.)	mm (in.)	mm (in.)
6	-QC4-BSM6-B	23.1 (0.91)	67.8 (2.67)	11.7 (0.46)	6.4 (0.25)
10	-QC6-BSM10-B	26.2 (1.03)	75.9 (2.99)	16.8 (0.66)	6.9 (0.27)
12	-QC8-BSM12-B	30.7 (1.21)	90.4 (3.56)	19.6 (0.77)	6.6 (0.26)

Full-flow bodies

Tube Fitting

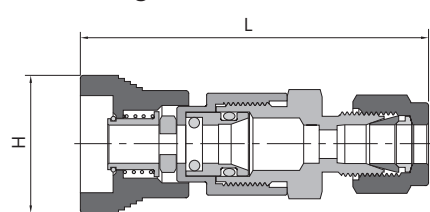

Tube Size	Basic Ordering Number	H	L
in.		in. (mm)	in. (mm)
1/8	-QC4-S2-BF	0.91 (23.1)	2.26 (57.4)
1/4	-QC4-S4-BF	0.91 (23.1)	2.30 (58.4)
3/8	-QC6-S6-BF	1.03 (26.2)	2.58 (65.5)
1/2	-QC8-S8-BF	1.21 (30.7)	3.09 (78.5)
mm		mm (in.)	mm (in.)
6	-QC4-SM6-BF	23.1 (0.91)	58.4 (2.30)
10	-QC6-SM10-BF	26.2 (1.03)	68.1 (2.68)
12	-QC8-SM12-BF	30.7 (1.21)	78.5 (3.09)

Male NPT

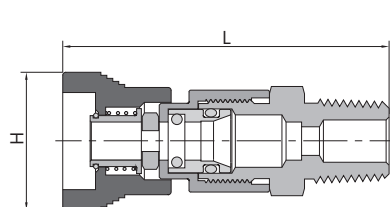

NPT Size	Basic Ordering Number	H	L
		in. (mm)	in. (mm)
1/8	-QC4-NT2-BF	0.91 (23.1)	2.01 (51.1)
1/4	-QC4-NT4-BF	0.91 (23.1)	2.16 (54.9)
1/4	-QC6-NT4-BF	1.03 (26.2)	2.38 (60.5)
3/8	-QC6-NT6-BF	1.03 (26.2)	2.38 (60.5)
1/2	-QC8-NT8-BF	1.21 (30.7)	2.97 (75.4)

Female NPT

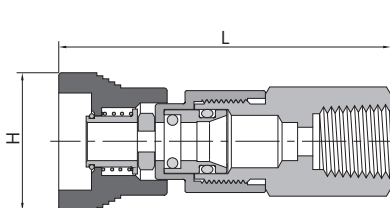

NPT Size	Basic Ordering Number	H	L
		in. (mm)	in. (mm)
1/8	-QC4-FNT2-BF	0.91 (23.1)	2.16 (54.9)
1/4	-QC4-FNT4-BF	0.91 (23.1)	2.42 (61.5)
1/4	-QC6-FNT4-BF	1.03 (26.2)	2.54 (65.4)
3/8	-QC6-FNT6-BF	1.03 (26.2)	2.57 (65.3)
1/2	-QC8-FNT8-BF	1.21 (30.7)	3.22 (81.8)

Male BSPT

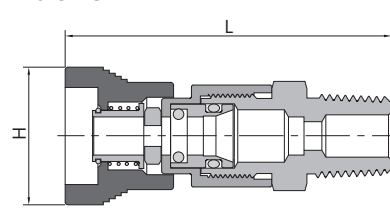

BSPT Size	Basic Ordering Number	H	L
		in. (mm)	in. (mm)
1/8	-QC4-RT2-BF	0.91 (23.1)	2.01 (51.1)
1/4	-QC4-RT4-BF	0.91 (23.1)	2.16 (54.9)
1/4	-QC6-RT4-BF	1.03 (26.2)	2.38 (60.5)
3/8	-QC6-RT6-BF	1.03 (26.2)	2.38 (60.5)
1/2	-QC8-RT8-BF	1.21 (30.7)	2.97 (75.4)

Female BSPT

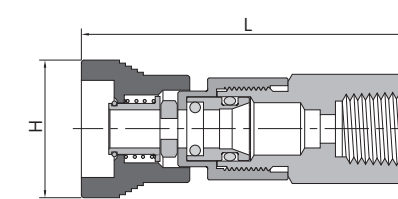

BSPT Size	Basic Ordering Number	H	L
		in. (mm)	in. (mm)
1/8	-QC4-FRT2-BF	0.91 (23.1)	2.16 (54.9)
1/4	-QC4-FRT4-BF	0.91 (23.1)	2.42 (61.5)
1/4	-QC6-FRT4-BF	1.03 (26.2)	2.54 (64.5)
3/8	-QC6-FRT6-BF	1.03 (26.2)	2.57 (65.3)
1/2	-QC8-FRT8-BF	1.21 (30.7)	3.22 (81.8)

Male JIC (AN) 37° Flare

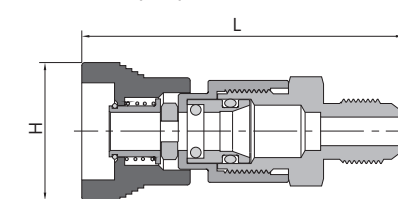

AN Tube Flare Size	Basic Ordering Number	H	L
in.		in. (mm)	in. (mm)
1/4	-QC4-AN4-BF	0.91 (23.1)	2.17 (55.1)
3/8	-QC6-AN6-BF	1.03 (26.2)	2.41 (61.2)
1/2	-QC8-AN8-BF	1.21 (30.7)	2.92 (74.2)

Hose Connector

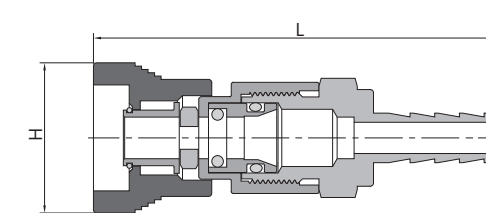

Hose Size	Basic Ordering Number	H	L
in.		in. (mm)	in. (mm)
1/4	-QC4-HC4-BF	0.91 (23.1)	2.41 (61.2)
3/8	-QC6-HC6-BF	1.03 (26.2)	2.72 (69.1)
1/2	-QC8-HC8-BF	1.21 (30.7)	3.20 (81.3)

Bulkhead Tube Fitting

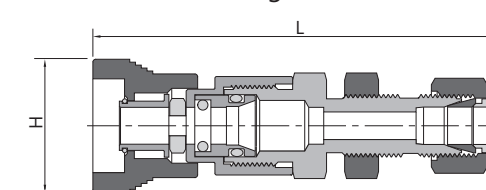

Tube Size	Basic Ordering Number	H	L	Min. Panel Hole	Max. Panel Thickness
in.		in. (mm)	in. (mm)	in. (mm)	in. (mm)
1/4	-QC4-BS4-BF	0.91 (23.1)	2.67 (67.8)	0.47 (11.9)	0.25 (6.4)
3/8	-QC6-BS6-BF	1.03 (26.2)	2.98 (75.7)	0.60 (15.2)	0.27 (6.9)
1/2	-QC8-BS8-BF	1.21 (30.7)	3.56 (90.4)	0.78 (19.8)	0.26 (6.6)
mm		mm (in.)	mm (in.)	mm (in.)	mm (in.)
6	-QC4-BSM6-BF	23.1 (0.91)	67.8 (2.67)	11.7 (0.46)	6.4 (0.25)
10	-QC6-BSM10-BF	26.2 (1.03)	75.9 (2.99)	16.8 (0.66)	6.9 (0.27)
12	-QC8-BSM12-BF	30.7 (1.21)	90.4 (3.56)	19.6 (0.77)	6.6 (0.26)

Keyed QC Series

FINELOK keyed quick-connects provide a Reliable mechanical lockout system to prevent accidental intermixing of different lines in multifluid or multipressure systems.

QC Series Key Numbers and Sleeve Outside Diameters

Key Number and Color	QC4		QC6		QC8	
	Body Sleeve	Stem Sleeve	Body Sleeve	Stem Sleeve	Body Sleeve	Stem Sleeve
	in. (mm)	in. (mm)	in. (mm)	in. (mm)	in. (mm)	in. (mm)
K1 black	0.96 (24.4)	0.82 (20.8)	1.13 (28.7)	0.99 (25.1)	1.26 (32.0)	1.10 (27.9)
K2 orange	0.99 (25.1)	0.85 (21.6)	1.16 (29.5)	1.02 (25.9)	1.29 (32.8)	1.14 (29.0)
K3 green	1.02 (25.9)	0.88 (22.4)	1.19 (30.2)	1.05 (26.7)	1.32 (33.5)	1.17 (29.7)
K4 yellow	1.05 (26.7)	0.91 (23.1)	1.22 (31.0)	1.08 (27.4)	1.35 (34.3)	1.20 (30.5)
K5 blue	1.08 (27.4)	0.94 (23.9)	1.24 (31.5)	1.11 (28.2)	1.38 (35.1)	1.23 (31.2)
K6 white	1.11 (28.2)	0.97 (24.6)	1.28 (32.5)	1.14 (29.0)	1.41 (35.8)	1.26 (32.0)
K7 purple	1.14 (29.0)	1.00 (25.4)	1.31 (33.3)	1.17 (29.7)	1.44 (36.6)	1.29 (32.8)
K8 brown	1.17 (29.7)	1.03 (26.2)	1.34 (34.0)	1.20 (30.5)	1.47 (37.3)	1.32 (33.5)

Protectors

Stem Protector

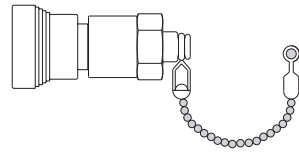

Series	Basic Ordering Number
QC4	-QC4-SP
QC6	-QC6-SP
QC8	-QC8-SP

Body Protector

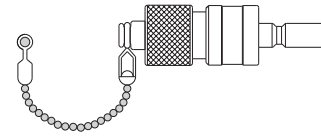

Series	Basic Ordering Number
QC4	-QC4-BP
QC6	-QC6-BP
QC8	-QC8-BP

☆ To order a protector, add material designator (SS for stainless steel or B for brass) as a prefix to the basic ordering number.

Example: SS-QC4-BP

☆ To order a keyed protector, add material designator (SS for stainless steel or B for brass) as a prefix and key designator from the table below as a suffix to the ordering number.

Example: SS-QC4-BP-K2

Ordering Information

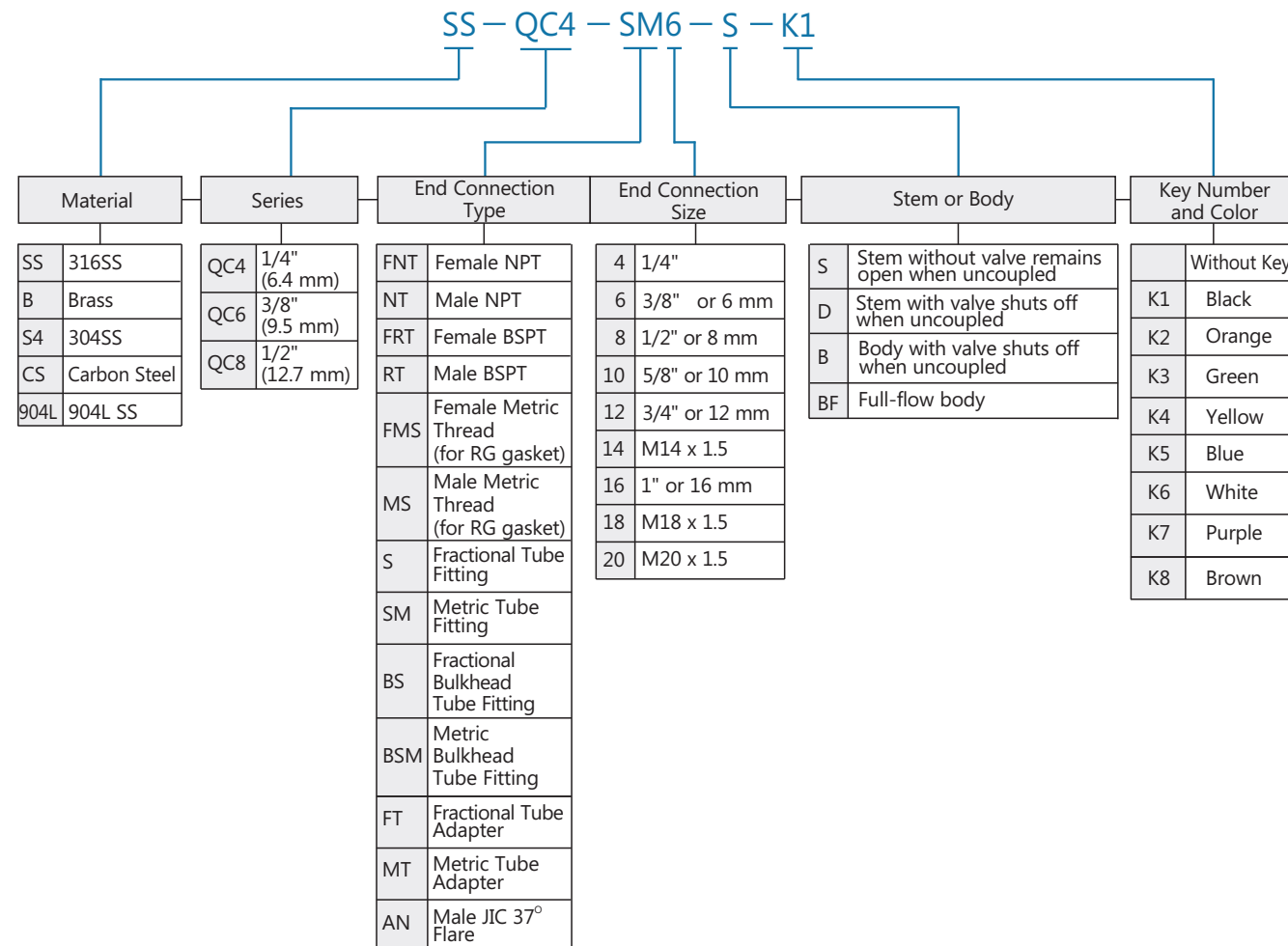

1. Sizes and types listed are standard. Other sizes and types are available on request.  
2. Dimensions are for reference only and are subject to change.

QF Series

Features

- ☆ Full flow
- ☆ Quick, easy operation
- ☆ Maximum working pressure: 6000 psig (414 bar)
- ☆ Materials: stainless steel, carbon steel, and brass
- ☆ Working temperatures:
  - 10°F to 400°F (-23°C to 204°C) with Fluorocarbon FKM seal
  - 10°F to 250°F (-23°C to 121°C) with Buna N seal
- ☆ Smooth, open bores without valving on either end to minimize pressure drop and allow easy cleaning.



Standard Materials of Construction

Component	Material
	316 SS Brass
Body, stem	316 SS Brass C36000
O-rings	Fluorocarbon FKM Buna N
Spring, snap ring, locking balls	316 SS
Lubricants	Silicone- and PTFE-based

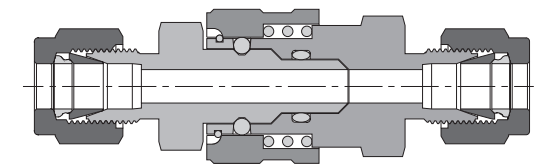

← Flow Direction →

Pressure-Temperature Ratings

Temperature °F (°C)	Stainless Steel with FKM O-ring				Brass with Buna N O-ring				Carbon Steel with Buna N O-ring			
	QF4	QF8	QF12	QF16	QF4	QF8	QF12	QF16	QF4	QF8	QF12	QF16
-10~70 (-23~20)	pressure rating, psig (bar)											
250 (121)	6000 (414)				4000 (275)				4000 (275)			
400 (204)	100 (6.9)				100 (6.9)				100 (6.9)			

In order to measure overall length in the coupled position, insertion depth should be deducted from any overall stem and body combination length.

Cautions:

- ☆ Do not uncouple under pressure.
- ☆ Do not insert foreign object into uncoupled stems and bodies.
- ☆ Re-lubricate stem seal O-ring periodically.

Dimensions

Stems

Tube Fitting

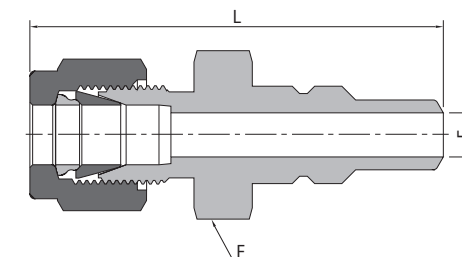

Insert Depth

Series	Insert Depth in. (mm)
QF4	0.78 (19.8)
QF8	0.81 (20.6)
QF12	0.90 (22.9)
QF16	0.94 (23.9)

Tube Size in.	Basic Ordering Number	Flow Coefficient (Cv)	E in. (mm)	F in.	L in. (mm)
1/4	-QF4-S4-S	2.2	0.19 (4.8)	9/16	1.77 (45.0)
3/8	-QF4-S6-S	2.8	0.24 (6.1)	11/16	1.77 (45.0)
3/8	-QF8-S6-S	2.8	0.28 (7.1)	7/8	1.88 (47.8)
1/2	-QF8-S8-S	13.0	0.41 (10.4)	7/8	1.99 (50.5)
3/4	-QF12-S12-S	26.0	0.62 (15.7)	1 1/16	2.15 (54.6)
1	-QF16-S16-S	45.0	0.88 (22.4)	1 3/8	2.45 (62.2)
mm			(mm) in.	mm	(mm) in.
6	-QF4-SM6-S	2.2	4.8 (0.19)	15	45.0 (1.77)
10	-QF8-SM10-S	2.8	7.1 (0.28)	22	48.5 (1.91)
12	-QF8-SM12-S	13.0	9.5 (0.37)	22	51.3 (2.02)
20	-QF12-SM20-S	26.0	15.7 (0.62)	30	54.6 (2.15)
25	-QF16-SM25-S	45.0	22.4 (0.88)	36	63.5 (2.50)

Stems

Male NPT

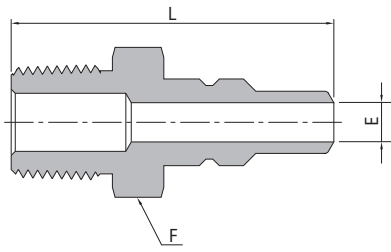

NPT Size	Basic Ordering Number	Flow Coefficient (Cv)	E	F	L
			in. (mm)	in.	in. (mm)
1/4	-QF4-NT4-S	1.7	0.24 (6.1)	9/16	1.59 (40.4)
3/8	-QF4-NT6-S	1.7	0.24 (6.1)	11/16	1.59 (40.4)
3/8	-QF8-NT6-S	7.1	0.41 (10.4)	7/8	1.65 (41.9)
1/2	-QF8-NT8-S	11.5	0.50 (12.7)	7/8	1.84 (46.7)
3/4	-QF12-NT12-S	23.6	0.72 (18.3)	1 1/16	2.03 (51.6)
1	-QF16-NT16-S	39.0	0.88 (22.4)	1 3/8	2.35 (59.7)

Female NPT

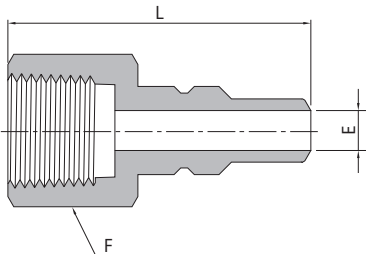

NPT Size	Basic Ordering Number	Flow Coefficient (Cv)	E	F	L
			in. (mm)	in.	in. (mm)
1/4	-QF4-FNT4-S	1.7	0.24 (6.1)	3/4	1.60 (40.6)
3/8	-QF4-FNT6-S	1.7	0.24 (6.1)	7/8	1.67 (42.4)
3/8	-QF8-FNT6-S	7.1	0.41 (10.4)	1 1/16	1.59 (40.4)
1/2	-QF8-FNT8-S	11.5	0.50 (12.7)	1 1/16	1.82 (46.2)
3/4	-QF12-FNT12-S	23.6	0.72 (18.3)	1 5/16	2.08 (52.8)
1	-QF16-FNT16-S	39.0	0.88 (22.4)	1 5/8	2.49 (63.2)

Male BSPT

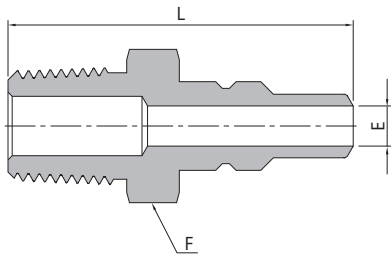

BSPT Size	Basic Ordering Number	Flow Coefficient (Cv)	E	F	L
			in. (mm)	in.	in. (mm)
1/4	-QF4-RT4-S	1.7	0.24 (6.1)	9/16	1.59 (40.4)
3/8	-QF4-RT6-S	1.7	0.24 (6.1)	11/16	1.59 (40.4)
3/8	-QF8-RT6-S	7.1	0.41 (10.4)	7/8	1.65 (41.9)
1/2	-QF8-RT8-S	11.5	0.50 (12.7)	7/8	1.84 (46.7)
3/4	-QF12-RT12-S	23.6	0.72 (18.3)	1 1/16	2.03 (51.6)
1	-QF16-RT16-S	39.0	0.88 (22.4)	1 3/8	2.35 (59.7)

Female BSPT

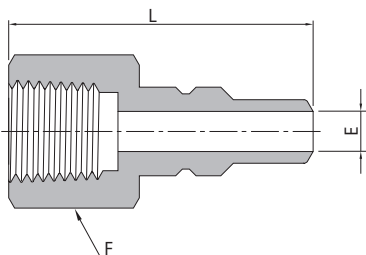

BSPT Size	Basic Ordering Number	Flow Coefficient (Cv)	E	F	L
			in. (mm)	in.	in. (mm)
1/4	-QF4-FRT4-S	1.7	0.24 (6.1)	3/4	1.60 (40.6)
3/8	-QF4-FRT6-S	1.7	0.24 (6.1)	7/8	1.67 (42.4)
3/8	-QF8-FRT6-S	7.1	0.41 (10.4)	1 1/16	1.59 (40.4)
1/2	-QF8-FRT8-S	11.5	0.50 (12.7)	1 1/16	1.82 (46.2)
3/4	-QF12-FRT12-S	23.6	0.72 (18.3)	1 5/16	2.08 (52.8)
1	-QF16-FRT16-S	39.0	0.88 (22.4)	1 5/8	2.49 (63.2)

Bodies

Tube Fitting

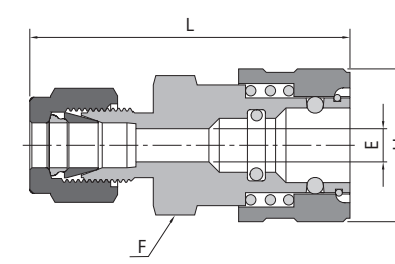

Tube Size	Basic Ordering Number	E	F	H	L
		in. (mm)	in.	in. (mm)	in. (mm)
1/4	-QF4-S4-B	0.19 (4.8)	11/16	0.87 (22.1)	1.80 (45.7)
3/8	-QF4-S6-B	0.28 (7.1)	11/16	0.87 (22.1)	1.81 (46.0)
3/8	-QF8-S6-B	0.28 (7.1)	1 1/16	1.30 (33.0)	2.17 (55.1)
1/2	-QF8-S8-B	0.47 (11.9)	1 1/16	1.30 (33.0)	2.23 (56.6)
3/4	-QF12-S12-B	0.62 (15.7)	1 1/2	1.66 (42.2)	2.45 (62.2)
1	-QF16-S16-B	0.88 (22.4)	1 11/16	1.88 (47.8)	2.75 (69.9)
mm		(mm) in.	mm	(mm) in.	(mm) in.
6	-QF4-SM6-B	4.8 (0.19)	18	22.1 (0.87)	45.7 (1.80)
10	-QF8-SM10-B	7.1 (0.28)	27	33.0 (1.30)	55.9 (2.20)
12	-QF8-SM12-B	10.4 (0.41)	27	33.0 (1.30)	57.4 (2.26)
20	-QF12-SM20-B	15.9 (0.63)	38	42.2 (1.66)	63.5 (2.50)
25	-QF16-SM25-B	21.8 (0.86)	46	47.8 (1.88)	70.0 (2.76)

Male NPT

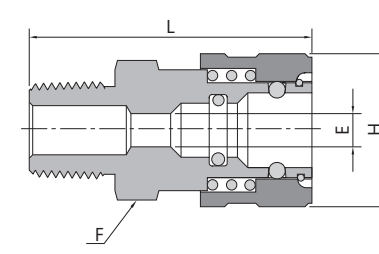

NPT Size	Basic Ordering Number	E	F	H	L
		in. (mm)	in.	in. (mm)	in. (mm)
1/4	-QF4-NT4-B	0.25 (6.4)	11/16	0.87 (22.1)	1.57 (39.9)
3/8	-QF4-NT6-B	0.37 (9.4)	11/16	0.87 (22.1)	1.57 (39.9)
3/8	-QF8-NT6-B	0.41 (10.4)	1 1/16	1.30 (33.0)	1.83 (46.5)
1/2	-QF8-NT8-B	0.50 (12.7)	1 1/16	1.30 (33.0)	2.08 (52.8)
3/4	-QF12-NT12-B	0.72 (18.3)	1 1/2	1.66 (42.2)	2.33 (59.2)
1	-QF16-NT16-B	0.88 (22.4)	1 11/16	1.88 (47.8)	2.65 (67.3)

Female NPT

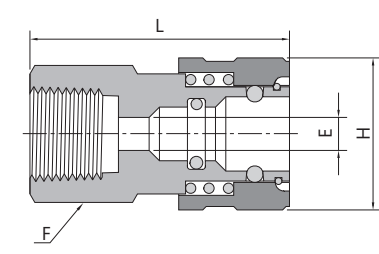

NPT Size	Basic Ordering Number	E	F	H	L
		in. (mm)	in.	in. (mm)	in. (mm)
1/4	-QF4-FNT4-B	0.38 (9.7)	3/4	0.87 (22.1)	1.50 (38.1)
3/8	-QF4-FNT6-B	0.38 (9.7)	7/8	0.87 (22.1)	1.63 (41.4)
3/8	-QF8-FNT6-B	0.59 (15.0)	1 1/16	1.30 (33.0)	1.73 (43.9)
1/2	-QF8-FNT8-B	0.63 (16.0)	1 1/16	1.30 (33.0)	1.73 (43.9)
3/4	-QF12-FNT12-B	0.88 (22.4)	1 1/2	1.66 (42.2)	1.89 (48.0)
1	-QF16-FNT16-B	1.06 (26.9)	1 11/16	1.88 (47.8)	2.12 (53.8)

Male BSPT

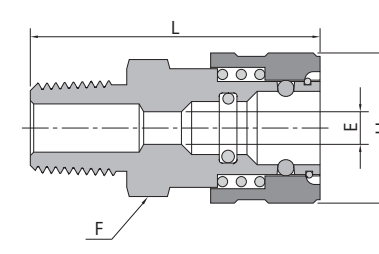

BSPT Size	Basic Ordering Number	E	F	H	L
		in. (mm)	in.	in. (mm)	in. (mm)
1/4	-QF4-RT4-B	0.25 (6.4)	11/16	0.87 (22.1)	1.57 (39.9)
3/8	-QF4-RT6-B	0.37 (9.4)	11/16	0.87 (22.1)	1.57 (39.9)
3/8	-QF8-RT6-B	0.41 (10.4)	1 1/16	1.30 (33.0)	1.83 (46.5)
1/2	-QF8-RT8-B	0.50 (12.7)	1 1/16	1.30 (33.0)	2.08 (52.8)
3/4	-QF12-RT12-B	0.72 (18.3)	1 1/2	1.66 (42.2)	2.33 (59.2)
1	-QF16-RT16-B	0.88 (22.4)	1 11/16	1.88 (47.8)	2.65 (67.3)

Female BSPT

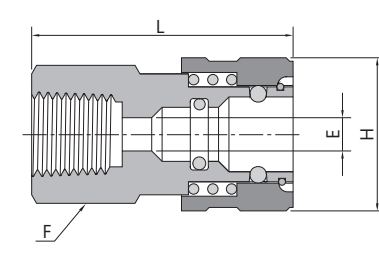

BSPT Size	Basic Ordering Number	E	F	H	L
		in. (mm)	in.	in. (mm)	in. (mm)
1/4	-QF4-FRT4-B	0.38 (9.7)	3/4	0.87 (22.1)	1.50 (38.1)
3/8	-QF4-FRT6-B	0.38 (9.7)	7/8	0.87 (22.1)	1.63 (41.4)
3/8	-QF8-FRT6-B	0.59 (15.0)	1 1/16	1.30 (33.0)	1.73 (43.9)
1/2	-QF8-FRT8-B	0.63 (16.0)	1 1/16	1.30 (33.0)	1.73 (43.9)
3/4	-QF12-FRT12-B	0.88 (22.4)	1 1/2	1.66 (42.2)	1.89 (48.0)
1	-QF16-FRT16-B	1.06 (26.9)	1 11/16	1.88 (47.8)	2.12 (53.8)

Protectors

Stem Protector

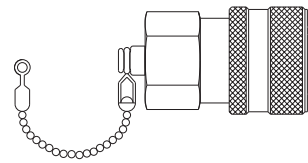

Series	Basic Ordering Number
QF4	-QF4-SP
QF8	-QF8-SP
QF12	-QF12-SP
QF16	-QF16-SP

Body Protector

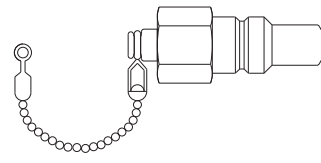

Series	Basic Ordering Number
QF4	-QF4-BP
QF8	-QF8-BP
QF12	-QF12-BP
QF16	-QF16-BP

© To order a protector, add material designator (SS for stainless steel or B for brass ) as a prefix to the basic ordering number.  
Example: SS-QF4-BP

Ordering Information

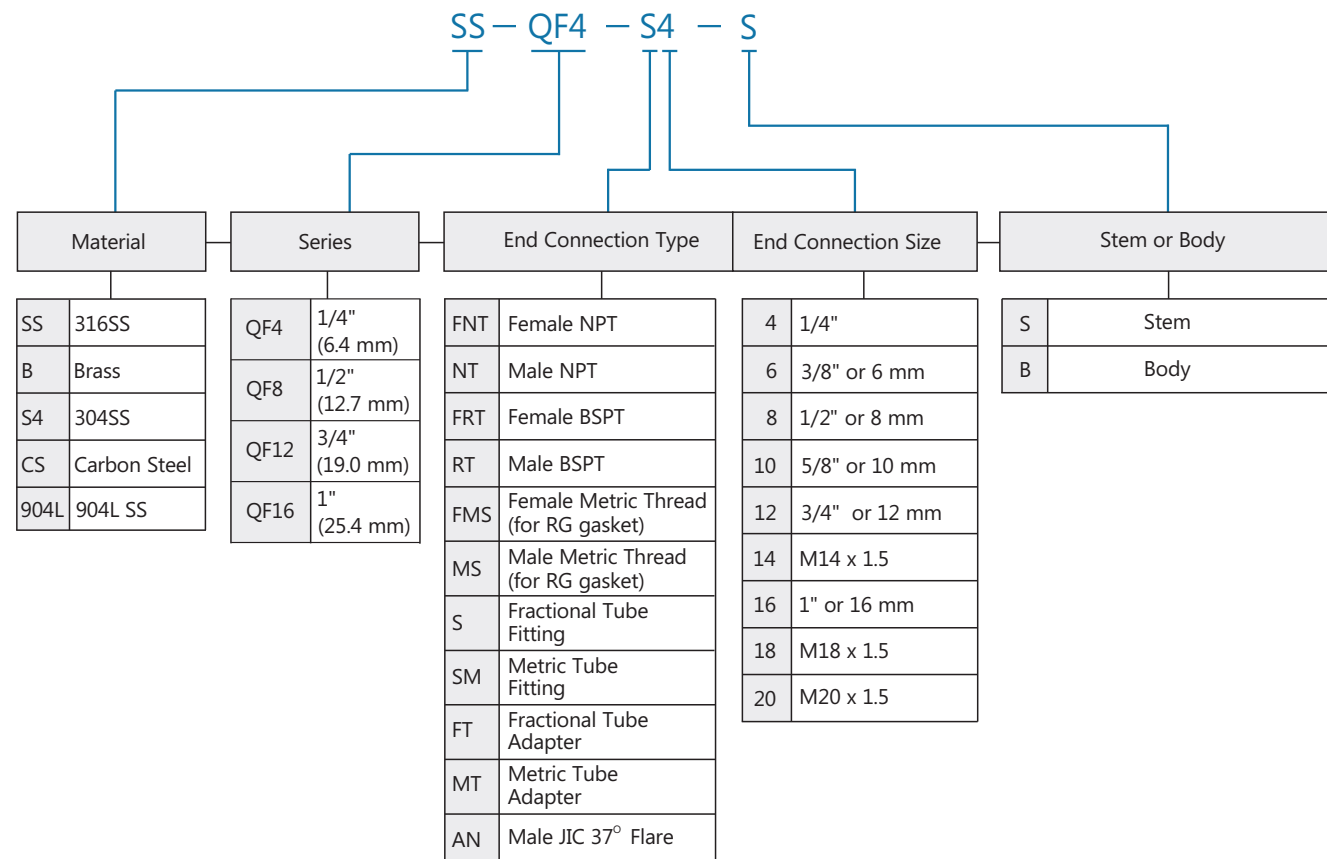

1. Dimensions are for reference only and are subject to change.
2. Sizes and types listed are standard. Other sizes and types are available on request.

QV Series

Features

- ☆ Large flow area ensure high flow capacity.
- ☆ Positive valve stop. The perch maintains valve alignment and provides metal to metal valve stop to ensure that the valves fully open.
- ☆ Hardened nipples and sleeves and solid barstock construction make for a quality coupling with maximum resistance to damage from hydraulic and mechanical shock.
- ☆ The seal is designed to withstand high pressure and provide reliable sealing.
- ☆ Durable ball-locking mechanism assures reliable connection.
- ☆ Working temperatures:
  - 10°F to 400°F (-23°C to 204°C) with Fluorocarbon FKM seal
  - 10°F to 250°F (-23°C to 121°C) with Buna N seal

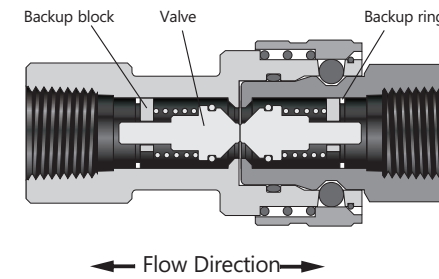

Standard Materials of Construction

Component	Material	
	316 SS	Brass
Body, Body sleeve, stem, valve, backup block	316 SS	Brass C36000
O-rings	Fluorocarbon FKM	Buna N
Spring, snap ring, locking balls	316 SS	
Lubricants	Silicone- and PTFE-based	

Pressure-Temperature Ratings

Body Material	Stainless Steel						Brass					
	Series	QV2	QV4	QV6	QV8	QV12	QV16	QV2	QV4	QV6	QV8	QV12
O-ring	FKM						Buna N					
Temperature Range	-10°F to 400°F (-23°C to 204°C)						-10°F to 250°F (-23°C to 121°C)					
Working Pressue psig (bar)	2000 (137)		1500 (103)		1000 (68.9)		1000 (68.9)					

In order to measure overall length in the coupled position, the insertion depth should be deducted from any overall stem and body combination length.

Insert Depth

Series	Insert Depth in. (mm)
QV2	0.71 (18.0)
QV4	0.81 (20.6)
QV6	0.89 (22.5)
QV8	1.01 (25.6)
QV12	1.26 (32.1)
QV16	1.42 (36.1)

Cautions:

- ☆ Do not insert foreign object into uncoupled stems and bodies.
- ☆ Re-lubricate stem seal O-ring periodically.



### Dimensions

#### Stems

Female NPT

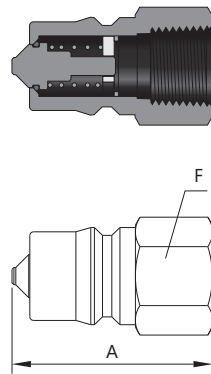

Female NPT				
NPT Size	Basic Ordering Number	Flow coefficient (Cv)	A	F
			in. (mm)	in.
1/8	-QV2-FNT2-D	0.8	1.16 (29.5)	9/16
1/4	-QV4-FNT4-D	3.0	1.39 (35.3)	3/4
3/8	-QV6-FNT6-D	6.0	1.50 (38.1)	7/8
1/2	-QV8-FNT8-D	12.0	1.75 (44.5)	1 1/8
3/4	-QV12-FNT12-D	28.0	2.16 (54.9)	1 3/8
1	-QV16-FNT16-D	50.0	2.91 (73.9)	1 5/8

Female BSPT

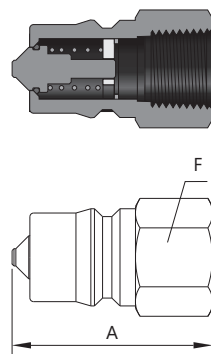

Female BSPT				
BSPT Size	Basic Ordering Number	Flow coefficient (Cv)	A	F
			in. (mm)	in.
1/8	-QV2-FRT2-D	0.8	1.16 (29.5)	9/16
1/4	-QV4-FRT4-D	3.0	1.39 (35.3)	3/4
3/8	-QV6-FRT6-D	6.0	1.50 (38.1)	7/8
1/2	-QV8-FRT8-D	12.0	1.75 (44.5)	1 1/8
3/4	-QV12-FRT12-D	28.0	2.16 (54.9)	1 3/8
1	-QV16-FRT16-D	50.0	2.58 (65.5)	1 5/8

#### Bodies

Female NPT

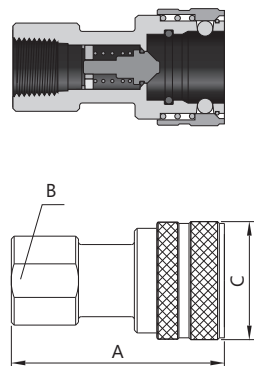

Female NPT				
NPT Size	Basic Ordering Number	A	B	C
		in. (mm)	in. (mm)	in. (mm)
1/8	-QV2-FNT2-B	1.90 (48.3)	0.63 (15.9)	0.96 (24.4)
1/4	-QV4-FNT4-B	2.26 (57.4)	0.81 (20.6)	1.14 (29.0)
3/8	-QV6-FNT6-B	2.49 (63.2)	0.88 (22.2)	1.40 (35.6)
1/2	-QV8-FNT8-B	2.87 (72.9)	1.13 (28.6)	1.77 (45.0)
3/4	-QV12-FNT12-B	3.56 (90.4)	1.31 (33.3)	2.14 (54.4)
1	-QV16-FNT16-B	4.18 (106.2)	1.63 (41.3)	2.52 (64.0)

Female BSPT

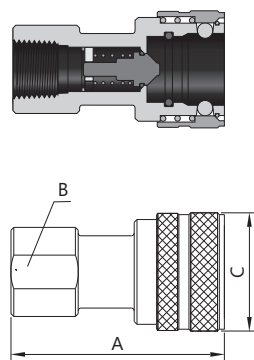

Female BSPT				
NPT Size	Basic Ordering Number	A	B	C
		in. (mm)	in. (mm)	in. (mm)
1/8	-QV2-FRT2-B	1.90 (48.3)	0.69 (17.5)	0.96 (24.4)
1/4	-QV4-FRT4-B	2.26 (57.4)	0.81 (20.6)	1.14 (29.0)
3/8	-QV6-FRT6-B	2.49 (63.2)	0.88 (22.2)	1.40 (35.6)
1/2	-QV8-FRT8-B	2.87 (72.9)	1.13 (28.6)	1.77 (45.0)
3/4	-QV12-FRT12-B	3.56 (90.4)	1.31 (33.3)	2.14 (54.4)
1	-QV16-FRT16-B	4.18 (106.2)	1.63 (41.3)	2.52 (64.0)

### Protectors

Stem Protector

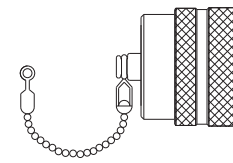

Series	Basic Ordering Number
QV2	-QV2-SP
QV4	-QV4-SP
QV6	-QV6-SP
QV8	-QV8-SP
QV12	-QV12-SP
QV16	-QV16-SP

Body Protector

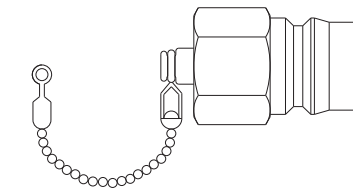

Series	Basic Ordering Number
QV2	-QV2-BP
QV4	-QV4-BP
QV6	-QV6-BP
QV8	-QV8-BP
QV12	-QV12-BP
QV16	-QV16-BP

☆ To order a protector, add material designator (SS for stainless steel or B for brass) as a prefix to the basic ordering number.

Example: SS-QV4-BP

### Ordering Information

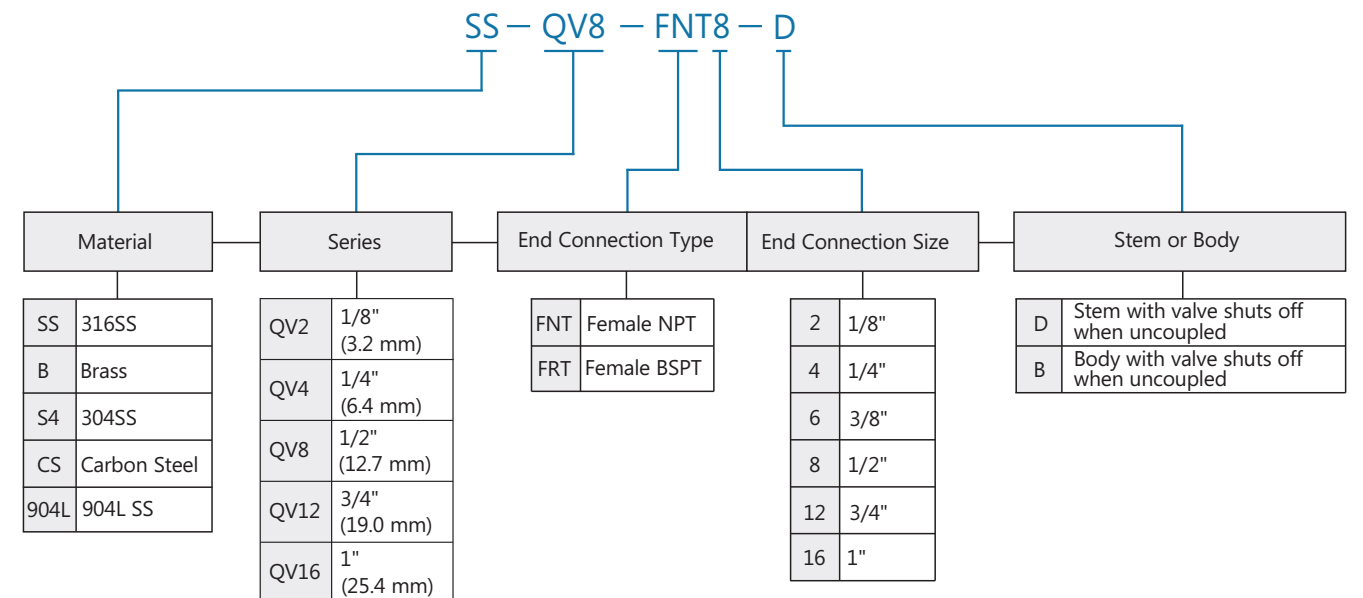

1. Dimensions are for reference only and are subject to change.

2. Sizes and types listed are standard. Other sizes and types are available on request.