



ALSONIC-EG

Ultrasonic Thermal Energy Meter
Model Alsonic-EG

GENERAL

Alsonic-Energy meters feature transit-time ultrasonic flow measurement with two PT 100 temperature sensors or customer-supplied RTD sensors for calculating total and instantaneous energy consumption. Flow measurement may be achieved via clamp-on, spool piece, or insertion-type sensors. Our microprocessor based, user friendly field programmable flow measurement technique creates no interruption of the process flow and has low installation costs.

FEATURES

- ❑ Measures energy consumption rate and total
- ❑ Compact or wall mount version
- ❑ Proven ultrasonic technology for flow measurement and PT 100 for temperature
- ❑ Clamp-on, spool piece or insertion mounting for flow measurement
- ❑ Wide range velocities - 0.03 ~ ±105 feet/sec (0.01 ~ ±32 m/s)
- ❑ Transducers for pipe sizes ranging from ½" ~ 240" (15 ~ 6000 mm)
- ❑ Excellent accuracy - ±0.5% of reading.
- ❑ RS485 and Modbus communication protocols available
- ❑ 4-20 mA and pulse outputs with available relays and alarms
- ❑ Data logger function - includes time & date, totalizer, diagnostics
- ❑ Response time less than 1 second
- ❑ NIST traceable calibration certificate

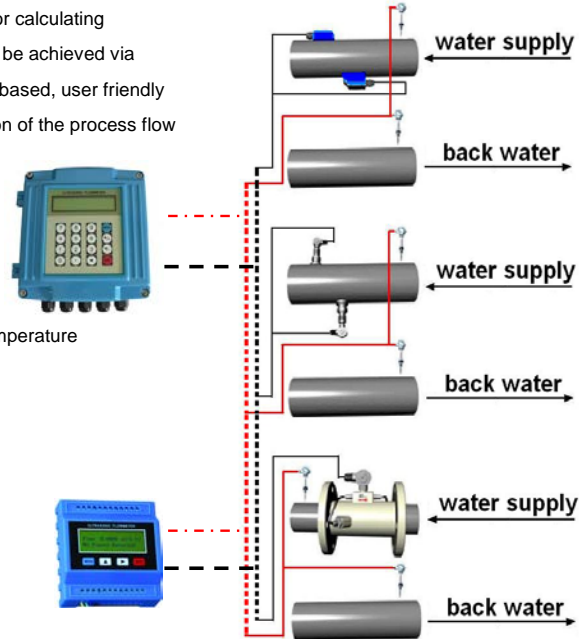

SPECIFICATION

- Flow measurement : Transit time ultrasonic method
- Transducer type : clamp-on, spool piece, or insertion
- Temperature measure : Platinum 100 RTDs
- Pipe Size : ½"-240" (25-6000mm)
- Pipe Material : Cast Iron, Stainless Steel, Ductile Iron
Copper, PVC, Aluminum, Asbestos
Fiberglass... etc.
- Liner Material : Tar Epoxy, Rubber, Mortar, Polypropylene,
Polystyryl, Polystyrene, Polyester, Ebonite,
Polyethylene, Teflon... etc.
- Fluid Velocity : 0.03 ~ ±105 feet/sec (0.01 ~ ±32 m/s)
- Resolution : 0.0003 feet/sec (0.0001 m/s)
- Liquid temperature : -40 ~ 120 °C
- Suspended solids : <2%; particle size smaller than 75µm
- Engineering units : Metric or English (US)
- Accuracy : ± 1%±2% of reading from 1.5 - 100 ft/sec
± 0.5% of reading (online calibration)
- Repeatability : ±0.5% of reading
- Communication : Isolated RS 485, MODBUS, GPRS/GSM
M-bus, Bacnet, or any other protocol
- Measurement period : 0 to 99s
- Ambient Temperature : -4 ~ 122 °F (-20 ~ 50 °C)
- Mounting : wall mounting or integral
- Display : LCD with backlight, 2 x 20 characters
1-line, non-backlit 7 digit LCD (ILD version)
- Keypad : 4 x 4 tactile-feedback membrane keypad
Displays energy rate, total consumption,
temperature, instantaneous flow rate
accumulated flow rate, velocity, time
- Max. Cable Length : 500' (150 m)
- Power : ≤ 2W
- Power Supply (AC) : 90 ~ 260V_{AC}, 50/60 Hz
- Power Supply (DC) : 9-30 V_{DC}
3.6V Li battery, 6 years of life (ILD version)
- Data Storage : Up to 64 days std, 36 mos. w/ ILD version
Time and corresponding flow rates of the
last 64 times power on/off events
- Signal outputs : Manual or automatic flow loss consumption
4-20 mA , Impedance 0-1kΩ, pulse, relays
Isolated OCT for alarms (on/off with buzzer)
- Signal inputs : Two RTD channels, and additional inputs
- Response Time : < 1 second
- Enclosure : NEMA 4X (IP65)
- Sensor : IP68(Submersible)
- Weight : 4 lb. (2 kg) wall mount, 2 lb. (1 kg) integral

➤ **TRANSDUCER SPECIFICATION**

● **Standard-Transducers**

Fluid Temperature : -30 ~ +60 °C

Accuracy: 1.5%

Model	SCS (Small Size)	SCM (Medium Size)	SCL (Large Size)
Pipe Size	DN15-100mm	DN50-1000mm	DN300-6000mm



● **Insertion Transducers**

Fluid Temperature : -40 ~ +120 °C

Accuracy: 1%

Model	SIS (Standard)	SIL (Large Size)
Pipe Size	DN80-1000mm	DN300-6000mm

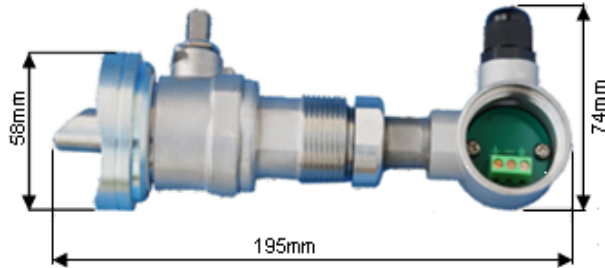

● **High Temperature Transducers**

Fluid Temperature : -40 ~ +120 °C

Accuracy: 1.5%

Model	STS (Small Size)	SHL (Medium Size)
Pipe Size	DN15-100mm	DN50-1000mm



● **Inline Type**

Fluid Temperature : -40 ~ +120 °C

Accuracy: 1%

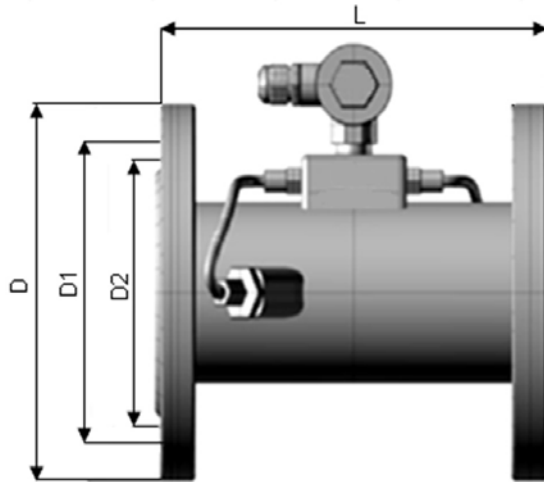

DN	L	D	D1	D2
50	200	165	125	99
65	200	185	145	118
80	225	200	160	132
100	250	220	180	156
125	250	250	210	184
150	300	285	240	211
200	350	340	295	266
250	450	405	355	319
300	500	460	410	370
350	550	520	470	429
400	600	580	525	480
450	700	640	585	548
500	800	715	650	609
600	1000	840	770	720
700	1100	910	840	794
800	1200	1025	950	901
900	1300	1125	1050	1001
1000	1400	1255	1170	1112

Note: all dimensions are mm unless stated

➤ Energy Ultrasonic Flowmeter

● Wall Mount

Size: 180x170x56mm
Material: cast aluminum
Setting: flow unit, zero, clear total flow, K-factor, date, passwords, linearity factor, etc....



Input: 3 channel 4-20mA analog input, 2 channel resistance signal input
Output: Isolation RS232/RS485 output, MODBUS 2 channel isolation OCT output 1 channel isolation 4-20mA output (two-wire)

Protection: NEMA 4X (IP65)

● Remote Module

Display: 1. status 2. error time 3. temperature difference 4. temperature 5. energy flow 6. total flow 7. flow rate 8. positive total flow



Size: 87 x 93 x 32 mm
Input: 3 channel 4-20mA analog input, 2 channel resistance signal input
Output: Isolation RS232/RS485 output, 2 channel isolation OCT output 1 channel isolation 4-20mA output (tow-wire), MODBUS

Protection: IP54

➤ ACCESSORIES



Modbus to Bacnet, M-Bus and other protocol convertors



PT1000 RTD's



Cable



Thickness gauge

➤ INSTALLATION

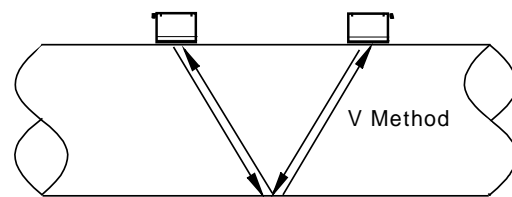
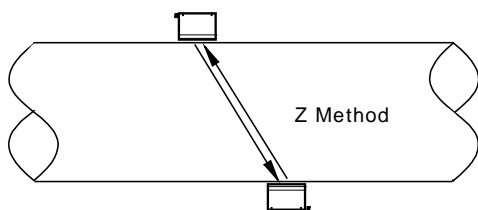

➤ STRAIGHT RUN PIPING REQUIREMENT

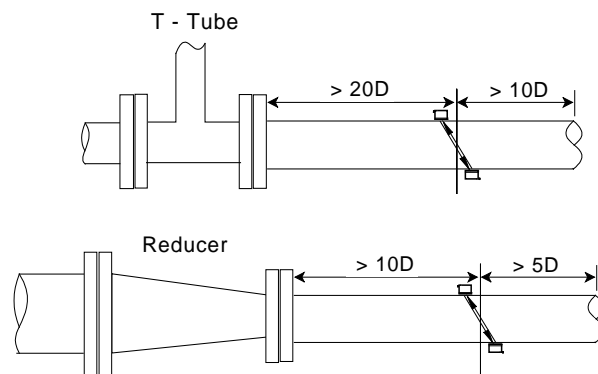
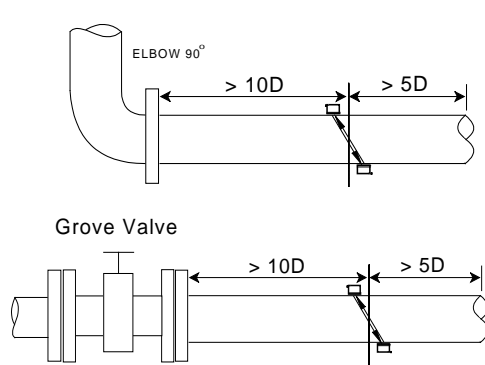



**** Please contact your local Smartmeasurement™ application engineer**

You also need to provide the following information:

Type of Fluid	Please provide the name of your fluid, including operating density and viscosity
Line Size	Nominal pipe size and connection (insertion, flanged, clamp, etc..)
Process Pressure and Temperature	We will calibrate your flowmeter as close to your operating conditions as possible
Type of Electronics	Output and installation type (compact, wall mount, panel mounted..)
Pipe Material	Pipe material (Copper, PVC, black iron, etc.)

7 Model Selection Guide

Alsonic-Energy										
Example 1: Alsonic-EG-WLE-100-SMC-C1-ST-DL										
Alsonic-EG-	**	**	**	**	**				Description	
Module-Energy, 4-20mA, RTD input, RS-485, OCT, 4-20mA output 	MUE									Transmitter
Wall mount with display, multichannel input/outputs, 4-20mA, RTD input, RS-485, OCT, 4-20mA output 	WLE									
Insertion Pt100 RTDs - 2m cable	100									RTD
Clamped Pt100 RTDs - 2m cable	C100									
Small clamp sensor, ½" - 4" (15 - 100mm)			SCS						Transducers	
Medium clamp sensor, 2" - 40" (50 - 1000mm)			SCM							
Large clamp sensor, 12" ~ 240" (300 ~ 6000 mm)			SCL							
High Temp.clamp sensor; -22-320 °F, ½" - 4" (15 - 100 mm)			SHS							
High Temp. clamp sensor; -22-320 °F, 2" - 40" (50 - 1000 mm)			SHL							
Standard insertion sensor			SIS							
Long insertion sensor			SIL							
SS #304 inline sensor (-30-120 °C); specify pipe size ***			DN**							
5M x 2 Cables			C1						Signal Cable Length	
10M x 2 Cables			C2							
15M x 2 Cables			C3							
thickness gauge			TT						Options	
Extra single cable. 10m * 2			C10							
Mounting Belt. 6m * 2			ST							
Extra RTD cable **m,			RC**							
Data logger for wall mount displays			DL							
IP68 Protection for transducers			68							